



Keo
Bad



Baderomsløsninger

Bathroom innovations

Et bad er alltid et spesielt rom. Det er et sted for avslapping, en oase av velvære og et veldig personlig rom.

For å hjelpe deg med å gjøre det til ditt eget, leverer vi høy kvalitet baderomsmøbler som er inspirert av naturen eller nåværende trender innen interiørdesign.

Enten det er et varmt treutseende, skifer av høy kvalitet, moderne betong eller høyglans og matte overflater: vi tilbyr estetisk tiltalende design som kan være individuelt kombinert for å passe alle krav. Så det kan du virkelig nyt tiden du bruker på badet ditt.

A bathroom is always a special room. It is a place of retreat, an oasis of well-being and a very personal space. To help you make it your very own, we supply high-quality bathroom furniture that has been inspired by nature or current trends in interior design.

Whether it's a warm wood look, high-quality slate, modern concrete or high gloss and matt surfaces: we offer aesthetically pleasing designs that can be individually combined to suit any requirements. So you can really enjoy the time you spend in your bathroom.

- 4** Inspirasjon
- 12** Trender
- 50** Løsniger og forslag
- 67** Fronter og håndtak



Baderomsløsninger og inspirasjon

Vi tilbyr estetisk tiltalende design som kan bli individuelt kombinert for å gjøre ethvert bad til et spesielt sted.



We offer aesthetically pleasing designs that can be individually combined to turn every bathroom into a special place.



6-7



LUX
817 Lakkert, Alpine hvit høyglans
817 Lacquer, alpine white high gloss



HØYGLANS HIGH GLOSS

Ved å bruke blanke overflater kan du oppnå en veldig høy kvalitet på badet, samtidig som det ser større ut.

By using shiny surfaces, you can achieve a very high quality look in your bathroom and at the same time make it look larger.

FLASH 455 Lakkert, Satin grå høyglans

455 Lacquered laminate, satin grey high gloss





6-9
8-8



FLASH

503 Lakkert, alpine hvit høyglans

503 Lacquered laminate, alpine white high gloss



CASCADA

772 Lakkert laminat, stein grå

772 Lacquered laminate, stone grey

STEMMINING

MOODS

Mens høyglans skaper et veldig moderne atmosfære gir tradisjonell stil mer hygge på badet. Vakre detaljer som for eksempel løpere, spesielle håndtak eller variasjoner i løsning utgjør også forskjeller her.

While high gloss elements create a very modern atmosphere, the country house style provides more cosiness in the bathroom. Beautiful details such as runners, special handles or variations in shape are also what make the difference here.



MATT

MATT

Fritt flytende bad eller med sokkelføtter som design, kontrast farge, kontinuerlige håndtak eller antifingeravtrykk belegg: Med matte fronter spesielt, er det detaljene som gjør et baderom til ditt eget.

Free floating elements or with pedestal feet as a design feature, with contrasting colour counters, continuous handles or the easy care anti-fingerprint coating: with matt fronts in particular, it's the detail that turns a room into your very own bathroom.



TOUCH

340 Lakkert laminat, sort supermatt

340 Lacquered laminate, black supermatt





EASYTOUCH

963 Lakkert laminat, Rust rød ultramatt

963 Lacquered laminate, rust red ultra matt



14 Varm og naturlig

warm grove



24

Stein effekt

floating rock



Trender

Trends

Vårt utvalg av baderomsmøbler av høy kvalitet gir fullstendig frihet når det gjelder design og nye kombinasjoner. Du kan velge bad fra fem nåværende livsstilstendenser eller til og med kombinere dem.

Tross alt handler dette om din personlige drømme bad.

Our range of high quality bathroom furniture offers complete freedom in terms of design and different combinations. You can choose your bathroom from five current lifestyle trends or even combine them. After all, this is about nothing less than your personal dream bathroom.



34

**Soft
touch**

soft
touch



28

**Urban og
industriell**

deep
industrial

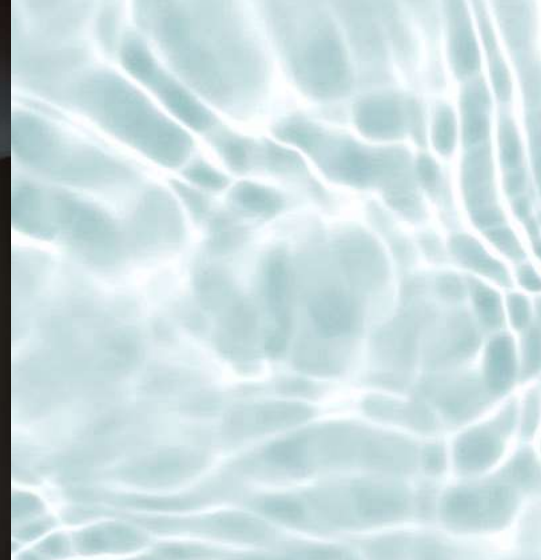

44

**Lys
og glans**

reflecting
light



14-15



Varm og naturlig

Det er ikke bare utseendet,
men også struktur av tre som gir liv
og atmosfære til bad.

It is not just the look but also the
structure of wood that brings life
and atmosphere to every bathroom.

Varm og lun



STRUCTURA
405 Sierra eik imitasjon

405 Eiche Sierra Nachbildung
405 Sierra oak reproduction





FØLELSEN AV STRUKTUR A SENSE OF STRUCTURE

Noen ganger koordinater, noen ganger kontraster.

Det naturlige utseendet på Sierra eik gir en følelse av struktur til designet i mange rom og sikrer et friskt, varmt utseende.

Sometimes coordinated, sometimes contrasting.
The natural look of the Sierra oak lends a sense of structure to the architecture of many rooms and ensures a fresh, warm look.

STRUCTURA
403 Nero eik imitasjon
403 Nero oak reproduction





SOFISTIKERT SOPHISTICATED

Det sorte i mørk eik utstråler selvsikker eleganse og gir hvert bad et moderne minimalistisk utseende.

The black of the Nero oak radiates self-confident elegance and gives every bathroom a modern minimalist look.



KOSELIG OG VARM

COSY AND WARM

Det mørke og ubehandlede struktur utseendet til Havanna eik gir vakre varme kontraster i et ellers kult bad.

The dark and untreated grained look of the Havana oak provides beautiful warm contrasts in an otherwise cool-looking bathroom.



STRUCTURA
402 Havana eik imitasjon
402 Havana oak reproduction





INLINE

551 lakkert, alpine hvit matt

551 Lacquer, honed alpine white

RIVA

887 Somerset eik imitasjon

887 Somerset oak reproduction



I KOMBINASJON IN COMBINATION

Trestruktur og fargede fronter skaper et unikt inntrykk når de brukes sammen.

Kombinasjonen av f. eks. vår lette Somerset eik og de matt hvite frontene, lager et luftig og enkelt utseende. Fargede fronter med Havana eik, derimot, gir opphav til et friskt og moderne utseende.

Wood looks and solid coloured fronts always create a unique impression when used together. The combination of our light Somerset oak and the matt white fronts, for example, create an air of special lightness. Coloured fronts with Havana oak, by contrast, give rise to a fresh and modern look.

TOUCH

337 Lakkert laminat, aqua supermatt

337 Lacquered laminate, aqua supermatt



24-25



Stein effekt floating rock

Tydelige linjer med en sofistikert utseende: skifer og marmor gir opphav til spesielt elegante omgivelser.

Clear lines with a sophisticated look: slate and marble give rise to particularly elegant surroundings.







STONEART

304 skifer steingrå imitasjon

304 Stone grey slate reproduction

STEIN STONE

Steingrå skiferelementer fungerer som sofistikerte høydepunkter på ethvert bad. Marmorelementer kan også kombineres med en f.eks. en super matt håndvask for å skape et moderne svart og hvitt utseende.

Stone grey slate elements act as sophisticated highlights in any bathroom. Marble elements can also be combined with a super matt hand basin to create a modern black and white look.





TOUCH

340 lakkert laminat, sort supermatt

340 Lacquered laminate, black supermatt

CC 273 Carrara marmor imitasjon

CC 273 Carrara marble reproduction



Urban og industriell

deep industrial



**Urbant og moderne:
betongen og sementutseende
skiller seg ut fra grått i markedet
på en elegant måte.**

Urban and modern: the concrete
and cement look stand out from the
grey mass market in an elegant way.



SEMENT CEMENT

Det moderne og puristiske utseendet på sement kommer godt til sin rett i bad i minimalistisk stil.

The modern and purist look of cement comes into its own in minimalist style bathrooms in particular.





CEMENTO
803 Lakkert, sement grå

803 Lacquer, cement grey

32-33



RIVA
892 Betong grå imitasjon
892 Concrete grey reproduction



BETONG

CONCRETE

Den store betong trenden har etablert seg globalt de siste årene. Og med rette, fordi den kule elegansen passer perfekt til moderne bad.

The big concrete look trend has established itself globally over the past few years. And rightly so, because its cool elegance perfectly suits a modern bathroom.





Soft Touch

soft
touch

**Tidløs høy kvalitet:
matt overflater har en beroligende
effekt, og ikke bare i små rom.**

Timelessly high quality: matt
surfaces have a calming effect,
and not just in small spaces.





TOUCH
340 Lakkert laminat, sort supermatt
340 Lacquered laminate, black supermatt





MATT I KOMBINASJON

MATT COMBINED

Matt fronter gir behagelige kontraster og skaper struktur kombinert med andre overflater som eik eller skifer.

Matt fronts provide pleasant contrasts and create structure when combined with other surfaces such as oak or slate.



38-39



KLAR LINJE CLEAR LINE

Lune og supermatte overflater gir elegante bad på både lys og mørk bakgrunn.

Subtly coloured and super matt surfaces provide elegant highlights on both light and dark backgrounds.





TOUCH

334 Lakkert laminat, skifergrå supermatt

334 Lacquered laminate, slate grey supermatt

40-41



TRADISJONELL STIL COUNTRY HOUSE STYLE

Med vakre utformede matte fronter kan du skape det koselig, og et uformelt minimalistisk utseende i baderommet ditt.

With beautifully crafted matt fronts, you can create a cosy to casual minimalistic look in your bathroom.



CASCADA
774 Lakkert laminat, hvit

774 Lacquered laminate, white



LYS - MØRK

LIGHT-DARK

Kontrasten mellom lyse fronter og et mørkt skrog skaper et moderne og spennende utseende.

The contrast between light fronts and a dark body creates a modern and exciting look.

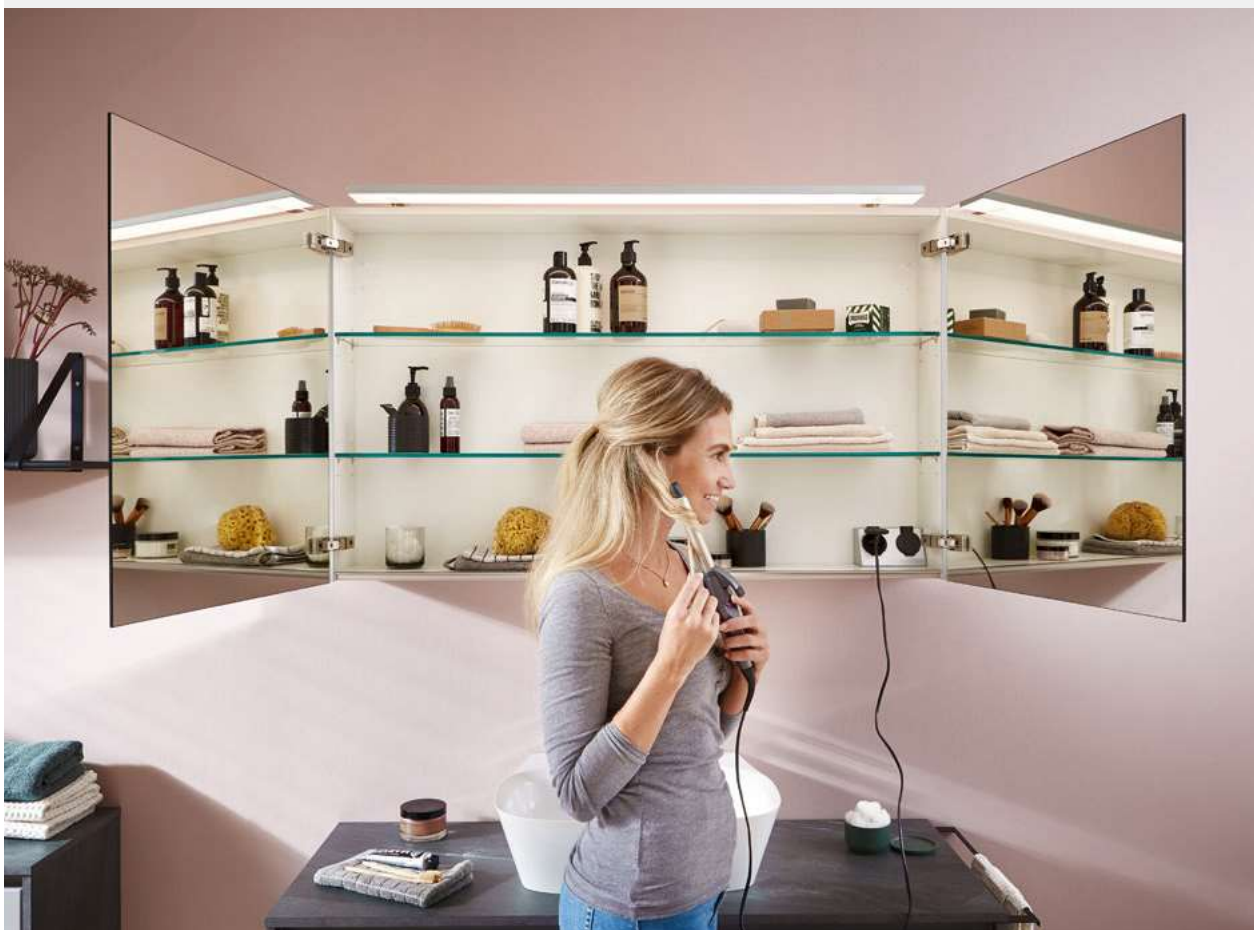



FASHION

165 Lakkert, stein grå matt

165 Lacquer, honed stone grey





Lys og Glans

reflecting light

Mer lys, mer plass: høyglans overflater skaper visuell dybde og få badet til å se større ut.

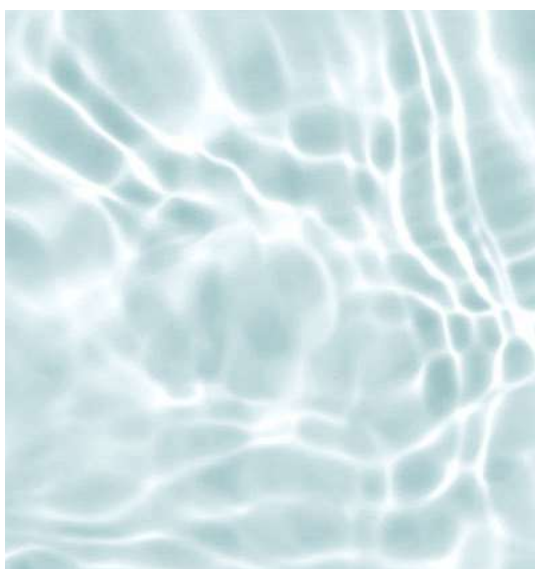

More light, more space: high gloss surfaces create visual depth and make the bathroom appear larger.





LUX
817 Lakkert, alpine hvit høyglans

817 Lacquer, alpine white high gloss



FLASH

503 Lakkert laminat, alpine hvit høyglans

503 Lacquered laminate, alpine white high gloss

BLIKKFANG EYE-CATCHER

Høyglans baderomsmøbler er et høydepunkt i ordets ekte betydning. I hvitt og behagelig lyst, skaper det også en veldig åpen utforming i rommet.

High gloss bathroom furniture is a highlight in the true sense of the word. In white and pleasantly illuminated, it also creates a very open architecture within the room.



VISUEL EFFEKT

VISUAL DEPTH

Høyglansfronter får alltid rommet til å se større ut. De er derfor ideelle for mindre bad, men de kommer også til sin rett i større rom.

High gloss fronts always make the space look bigger. They are therefore ideal for smaller bathrooms but they also come into their own in larger spaces.



FLASH
453 Lakkert laminat, skifergrå høyglans

453 Lacquered laminate, slate grey high gloss



LUX
819 Lakkert, satin grå høyglans
819 Lacquer, satin grey high gloss



PLANLEGGINGSFORSLAG

PLANNING SUGGESTIONS

Du kan alltid kombinere badermøbler individuelt for å passe dine behov. Din lokale forhandler vil gjerne hjelpe deg med planene dine.

You can always combine our bathroom furniture individually to suit your needs. Your local dealer would be happy to help you with your plans.

Bad med håndtak

Waschtischgröße Hand basin size

600 mm

BSET60-001

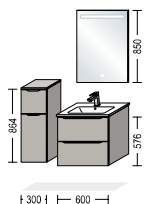

800 mm

BSET80-001

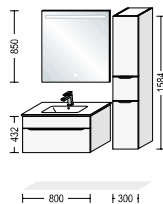

1000 mm

BSET100-001

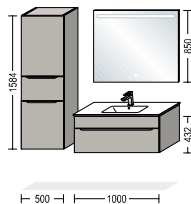

1200 mm

BSET120-001

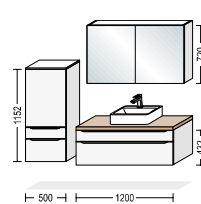

1500 mm

BSET150-001

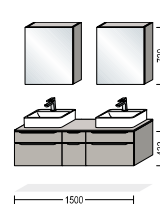

BSET60-002

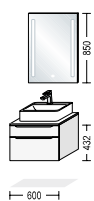

BSET80-002

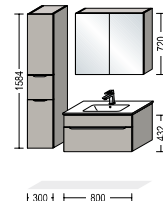

BSET100-002

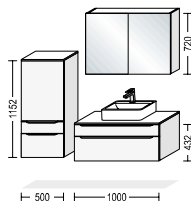

BSET120-002

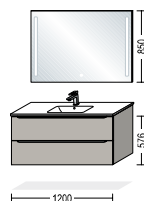

BSET150-002



BSET60-003

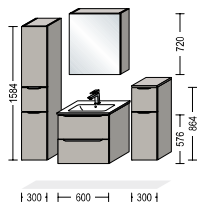

BSET80-003

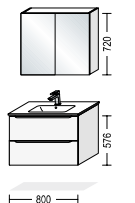

BSET100-003

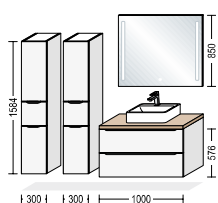

BSET120-003

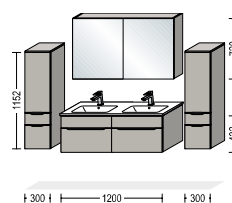

BSET80-004

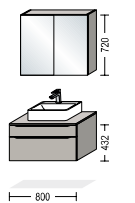

BSET120-004

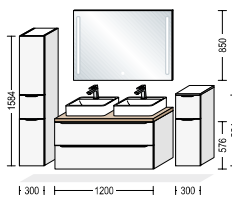

BSET80-005

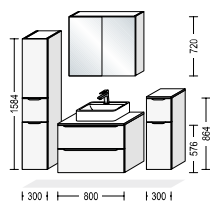

Håndtaksløst med gripeskinne

Waschtischgröße Hand basin size

600 mm

800 mm

1000 mm

1200 mm

1500 mm

NBSET60-001

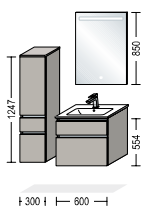

NBSET80-001

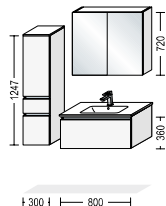

NBSET100-001

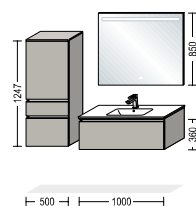

NBSET120-001

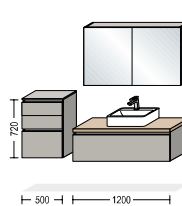

NBSET150-001

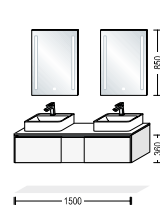

NBSET60-002

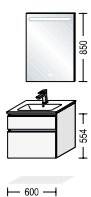

NBSET80-002

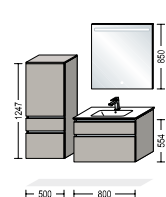

NBSET100-002

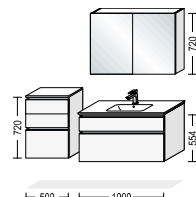

NBSET120-002

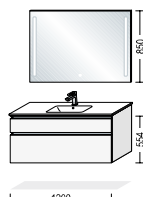

NBSET150-002

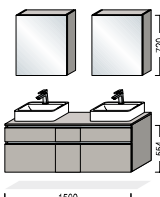

NBSET60-003

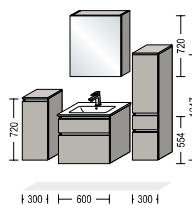

NBSET80-003



NBSET100-003

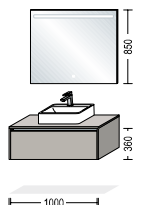

NBSET120-003

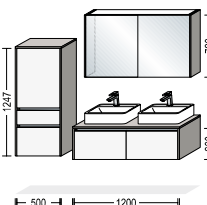

NBSET100-004

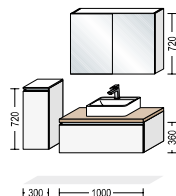

NBSET120-004

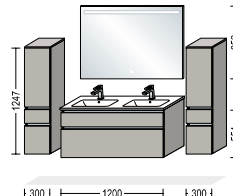

NBSET100-005

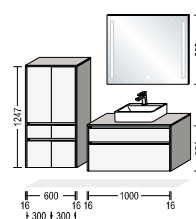

SPEZIFIKATIONEN SPECIFICATIONS

Med håndtak

Waschtischgröße Hand basin size

600 mm

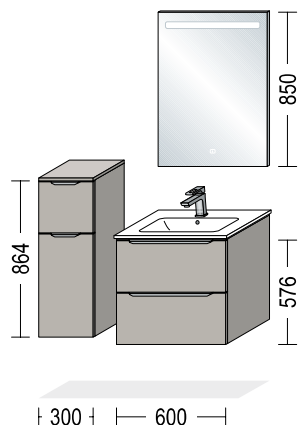

BSET60-001

1 x BSA 30-86

Badezimmer-Sideboard, 1 Auszug, 1 Tür, 1 Einlegeboden, 320 mm tief, 300 mm breit, 864 mm hoch
Bathroom sideboard, 1 pull-out, 1 door, 1 shelf, 320 mm deep, 300 mm wide, 864 mm high

1 x ADB16-35

Abdeckboden, 16 mm stark, 346 mm tief, 303 mm breit
Top shelf, 16 mm thick, 346 mm deep, 303 mm wide

1 x BWASA 60-58

Badezimmer-Waschtischschrank, 1 Innenblende, 1 Schubkasten mit Auszugsblende, 1 Auszug, 461 mm tief, 600 mm breit, 576 mm hoch
Bathroom vanity unit, 1 internal panel, 1 drawer with pull-out panel, 1 pull-out, 461 mm deep, 600 mm wide, 576 mm high

1 x 87706

Waschtisch MEGX 600C, 614 mm breit, 492 mm hoch, 142 mm tief
Hand basin MEGX 600C, 614 mm wide, 492 mm high, 142 mm deep

1 x SPLH 60

Spiegel mit horizontalem LED-Lichtfenster, 24 mm tief, 600 mm breit, 850 mm hoch
Mirror with horizontal LED light window, 24 mm deep, 600 mm wide, 850 mm high

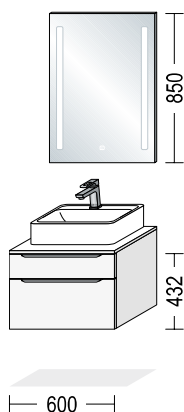

BSET60-002

1 x BWSA 60-43

Badezimmer-Waschtischschrank, 1 Schubkasten, 1 Auszug, 461 mm tief, 600 mm breit, 432 mm hoch
Bathroom vanity unit, 1 drawer, 1 pull-out, 461 mm deep, 600 mm wide, 432 mm high

1 x ADB16-59

Abdeckboden, 16 mm stark, 487 mm tief, 603 mm breit
Top shelf, 16 mm thick, 487 mm deep, 603 mm wide

1 x 87725

Aufsatzwaschtisch WB 0002 W 520C, 450 mm tief, 519 mm breit, 162 mm hoch
Surface-mounted hand basin WB 0002 W 520C, 450 mm deep, 519 mm wide, 162 mm high

1 x SPLV 60

Spiegel mit vertikalen LED-Lichtfenstern, 24 mm tief, 600 mm breit, 850 mm hoch
Mirror with vertical LED light windows, 24 mm deep, 600 mm wide, 850 mm high

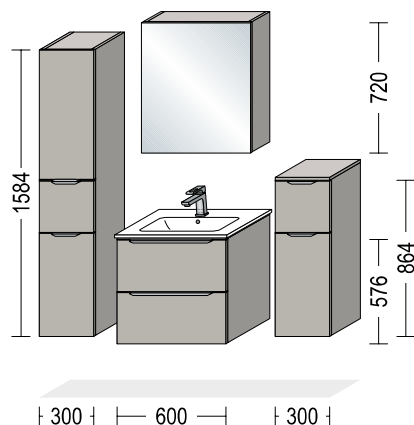

BSET60-003

1 x BMA 30-158

Badezimmer-Midischrank, 1 Tür, 1 Auszug, 1 Tür, 3 Einlegeböden, 320 mm tief, 300 mm breit, 1584 mm hoch
Bathroom Midi unit, 1 door, 1 pull-out, 1 door, 3 shelves, 320 mm deep, 300 mm wide, 1584 mm high

1 x BWASA 60-58

Badezimmer-Waschtischschrank, 1 Innenblende, 1 Schubkasten mit Auszugsblende, 1 Auszug, 461 mm tief, 600 mm breit, 576 mm hoch
Bathroom vanity unit, 1 internal panel, 1 drawer with pull-out panel, 1 pull-out, 461 mm deep, 600 mm wide, 576 mm high

1 x 87706

Waschtisch MEGX 600C, 492 mm tief, 614 mm breit, 142 mm hoch
Hand basin MEGX 600C, 492 mm deep, 614 mm wide, 142 mm high

1 x WBSP 60-02

Spiegelschrank, 1 Spiegeltür, 2 Glaseinlegeböden, 202 mm tief, 600 mm breit, 720 mm hoch
Mirrored bathroom cabinet, 1 mirrored door, 2 glass shelves, 202 mm deep, 600 mm wide, 720 mm high

1 x BSA 30-86

Badezimmer-Sideboard, 1 Auszug, 1 Tür, 1 Einlegeboden, 320 mm tief, 300 mm breit, 864 mm hoch
Bathroom sideboard, 1 pull-out, 1 door, 1 shelf, 320 mm deep, 300 mm wide, 864 mm high

1 x ADB16-35

Abdeckboden, 16 mm stark, 346 mm tief, 303 mm breit
Top shelf, 16 mm thick, 346 mm deep, 303 mm wide

Planleggingsforslag inkluderer ikke kraner, lys, håndtakstillegg eller stikkontakter. Disse må bestilles iht det angitte varenummeret.

Planning suggestions do not include taps, lights, handle surcharges or sockets. These must be ordered in addition to the set item number.

Waschtischgröße Hand basin size

800 mm

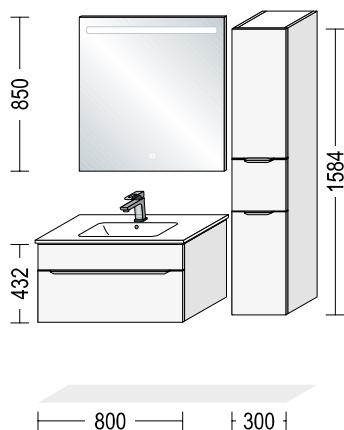

BSET80-001

1 x BWA 80-43

Badezimmer-Waschtischschrank, 1 feste Blende, 1 Auszug, 461 mm tief, 800 mm breit, 432 mm hoch
Bathroom vanity unit, 1 fixed panel, 1 pull-out, 461 mm deep, 800 mm wide, 432 mm high

1 x 87708

Waschtisch MEGX 800C, 492 mm tief, 814 mm breit, 142 mm hoch
Hand basin MEGX 800C, 492 mm deep, 814 mm wide, 142 mm high

1 x SPLH 80

Spiegel mit horizontalem LED-Lichtfenster, 24 mm tief, 800 mm breit, 850 mm hoch
Mirror with horizontal LED light window, 24 mm deep, 800 mm wide, 850 mm high

1 x BMA 30-158

Badezimmer-Midischrank, 1 Tür, 1 Auszug, 1 Tür, 3 Einlegeböden, 320 mm tief, 300 mm breit, 1584 mm hoch
Bathroom Midi unit, 1 door, 1 pull-out, 1 door, 3 shelves, 320 mm deep, 300 mm wide, 1584 mm high

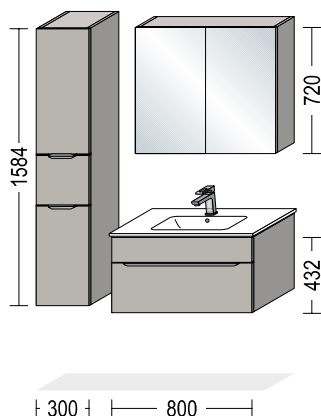

BSET80-002

1 x BMA 30-158

Badezimmer-Midischrank, 1 Tür, 1 Auszug, 1 Tür, 3 Einlegeböden, 320 mm tief, 300 mm breit, 1584 mm hoch
Bathroom Midi unit, 1 door, 1 pull-out, 1 door, 3 shelves, 320 mm deep, 300 mm wide, 1584 mm high

1 x BWA 80-43

Badezimmer-Waschtischschrank, 1 feste Blende, 1 Auszug, 461 mm tief, 800 mm breit, 432 mm hoch
Bathroom vanity unit, 1 fixed panel, 1 pull-out, 461 mm deep, 800 mm wide, 432 mm high

1 x 87708

Waschtisch MEGX 800C, 492 mm tief, 814 mm breit, 142 mm hoch
Hand basin MEGX 800C, 492 mm deep, 814 mm wide, 142 mm high

1 x WBSP 80-02

Spiegelschrank, 2 Spiegeltüren, 2 Glaseinlegeböden, 202 mm tief, 800 mm breit, 720 mm hoch
Mirrored bathroom cabinet, 2 mirrored doors, 2 glass shelves, 202 mm deep, 800 mm wide, 720 mm high

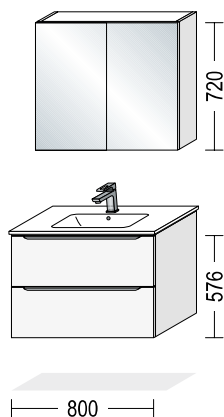

BSET80-003

1 x BWASA 80-58

Badezimmer-Waschtischschrank, 1 Innenblende, 1 Schubkasten mit Auszugsblende, 1 Auszug, 461 mm tief, 800 mm breit, 576 mm hoch
Bathroom vanity unit, 1 internal panel, 1 drawer with pull-out panel, 1 pull-out, 461 mm deep, 800 mm wide, 576 mm high

1 x 87708

Waschtisch MEGX 800C, 492 mm tief, 814 mm breit, 142 mm hoch
Hand basin MEGX 800C, 492 mm deep, 814 mm wide, 142 mm high

1 x WBSP 80-02

Spiegelschrank, 2 Spiegeltüren, 2 Glaseinlegeböden, 202 mm tief, 800 mm breit, 720 mm hoch
Mirrored bathroom cabinet, 2 mirrored doors, 2 glass shelves, 202 mm deep, 800 mm wide, 720 mm high

Planleggingsforslag inkluderer ikke kranner, lys, håndtakstillegg eller stikkontakter. Disse må bestilles iht det angitte varenummeret.

Planning suggestions do not include taps, lights, handle surcharges or sockets. These must be ordered in addition to the set item number.

SPEZIFIKATIONEN SPECIFICATIONS

Waschtischgröße Hand basin size

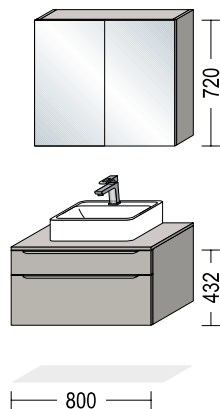
800 mm**BSET80-004**

1 x BWSA 80-43

Badezimmer-Waschtischschrank, 1 Schubkasten mit Holzrückwand, 1 Auszug, 461 mm tief, 800 mm breit, 432 mm hoch
Bathroom vanity unit, 1 drawer with wooden back panel, 1 pull-out, 461 mm deep, 800 mm wide, 432 mm high

1 x ADB16-59

Abdeckboden, 16 mm stark, 487 mm tief, 803 mm breit
Top shelf, 16 mm thick, 487 mm deep, 803 mm wide

1 x 87725

Aufsatzwaschtisch WB 0002 W 520C, 450 mm tief, 519 mm breit, 162 mm hoch
Surface-mounted hand basin WB 0002 W 520C, 450 mm deep, 519 mm wide, 162 mm high

1 x WBSP 80-02

Spiegelschrank, 2 Spiegeltüren, 2 Glaseinlegeböden, 202 mm tief, 800 mm breit, 720 mm hoch
Mirrored bathroom cabinet, 2 mirrored doors, 2 glass shelves, 202 mm deep, 800 mm wide, 720 mm high

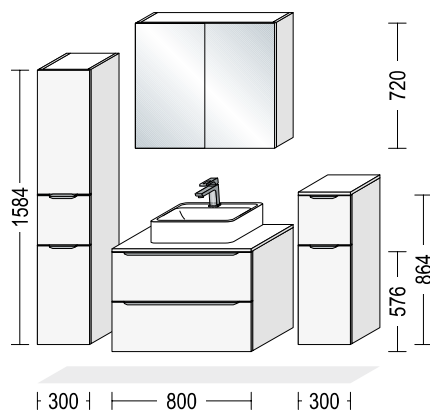
**BSET80-005**

1 x BMA 30-158

Badezimmer-Midischrank, 1 Tür, 1 Auszug, 1 Tür, 3 Einlegeböden, 320 mm tief, 300 mm breit, 1584 mm hoch
Bathroom Midi unit, 1 door, 1 pull-out, 1 door, 3 shelves, 320 mm deep, 300 mm wide, 1584 mm high

1 x BW2A 80-58

Badezimmer-Waschtischschrank, 2 Auszüge, 461 mm tief, 800 mm breit, 576 mm hoch
Bathroom vanity unit, 2 pull-outs, 461 mm deep, 800 mm wide, 576 mm high

1 x ADB16-59

Abdeckboden, 16 mm stark, 487 mm tief, 803 mm breit
Top shelf, 16 mm thick, 487 mm deep, 803 mm wide

1 x 87726

Aufsatzwaschtisch WB 0517 C 600C, 470 mm tief, 600 mm breit, 144 mm hoch
Surface-mounted hand basin WB 0517 C 600C, 470 mm deep, 600 mm wide, 144 mm high

1 x WBSP 80-02

Spiegelschrank, 2 Spiegeltüren, 2 Glaseinlegeböden, 202 mm tief, 800 mm breit, 720 mm hoch
Mirrored bathroom cabinet, 2 mirrored doors, 2 glass shelves, 202 mm deep, 800 mm wide, 720 mm high

1 x BSA 30-86

Badezimmer-Sideboard, 1 Auszug, 1 Tür, 1 Einlegeboden, 320 mm tief, 300 mm breit, 864 mm hoch
Bathroom sideboard, 1 pull-out, 1 door, 1 shelf, 320 mm deep, 300 mm wide, 864 mm high

1 x ADB16-35

Abdeckboden, 16 mm stark, 346 mm tief, 303 mm breit
Top shelf, 16 mm thick, 346 mm deep, 303 mm wide

Planleggingsforslag inkluderer ikke kranner, lys, håndtakstillegg eller stikkontakter. Disse må bestilles iht det angitte varenummeret.

Planning suggestions do not include taps, lights, handle surcharges or sockets. These must be ordered in addition to the set item number.

Waschtischgröße Hand basin size

1000 mm

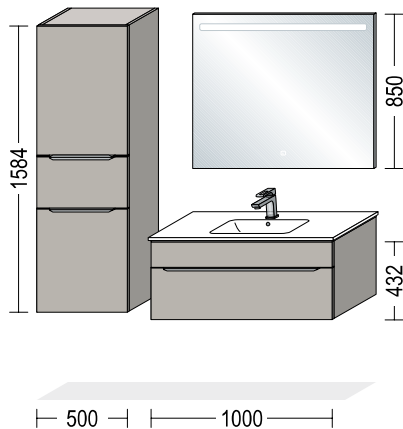

BSET100-001

1 x BMA 50-158

Badezimmer-Midischrank, 1 Tür, 1 Auszug, 1 Tür, 3 Einlegeböden,
320 mm tief, 500 mm breit, 1584 mm hoch
Bathroom Midi unit, 1 door, 1 pull-out, 1 door, 3 shelves,
320 mm deep, 500 mm wide, 1584 mm high

1 x BWA 100-43

Badezimmer-Waschtischschrank, 1 feste Blende, 1 Auszug,
461 mm tief, 1000 mm breit, 432 mm hoch
Bathroom vanity unit, 1 fixed panel, 1 pull-out,
461 mm deep, 1000 mm wide, 432 mm high

1 x 87710

Waschtisch MEGX 1000C, 492 mm tief, 1014 mm breit, 142 mm hoch
Hand basin MEGX 1000C, 492 mm deep, 1014 mm wide, 142 mm high

1 x SPLH 100

Spiegel mit horizontalem LED-Lichtfenster,
24 mm tief, 1000 mm breit, 850 mm hoch
Mirror with horizontal LED light window,
24 mm deep, 1000 mm wide, 850 mm high

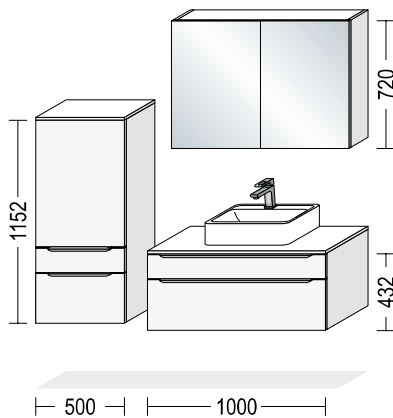

BSET100-002

1 x BMSA 50-115

Badezimmer-Midischrank, 1 Tür, 1 Schubkasten, 1 Auszug,
2 Einlegeböden, 320 mm tief, 500 mm breit, 1152 mm hoch
Bathroom Midi unit, 1 door, 1 drawer, 1 pull-out, 2 shelves,
320 mm deep, 500 mm wide, 1152 mm high

1 x ADB 16-35

Abdeckboden, 16 mm stark, 346 mm tief, 503 mm breit
Top shelf, 16 mm thick, 346 mm deep, 503 mm wide

1 x BWSA 100-43

Badezimmer-Waschtischschrank, 1 Schubkasten, 1 Auszug,
461 mm tief, 1000 mm breit, 432 mm hoch
Bathroom vanity unit, 1 drawer, 1 pull-out,
461 mm deep, 1000 mm wide, 432 mm high

1 x 87726

Aufsatzwaschtisch WB 0517 C 600C,
470 mm tief, 600 mm breit, 144 mm hoch
Surface-mounted hand basin WB 0517 C 600C,
470 mm deep, 600 mm wide, 144 mm high

1 x ADB16-59

Abdeckboden, 16 mm stark, 487 mm tief, 1003 mm breit
Top shelf, 16 mm thick, 487 mm deep, 1003 mm wide

1 x WBSP 100-02

Spiegelschrank, 2 Spiegeltüren, 2 Glaseinlegeböden,
202 mm tief, 1000 mm breit, 720 mm hoch
Mirrored bathroom cabinet, 2 mirrored doors, 2 glass shelves,
202 mm deep, 1000 mm wide, 720 mm high

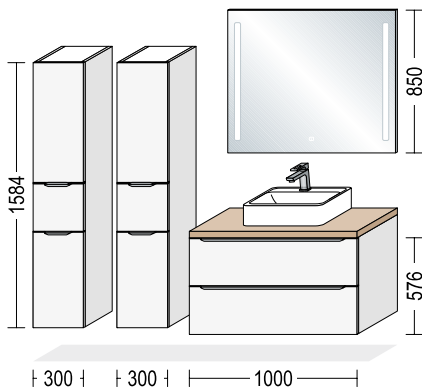

BSET100-003

2 x BMA 30-158

Badezimmer-Midischrank, 1 Tür, 1 Auszug, 1 Tür, 3 Einlegeböden,
320 mm tief, 300 mm breit, 1584 mm hoch
Bathroom Midi unit, 1 door, 1 pull-out, 1 door, 3 shelves,
320 mm deep, 300 mm wide, 1584 mm high

1 x BW2A 100-58

Badezimmer-Waschtischschrank, 2 Auszüge,
461 mm tief, 1000 mm breit, 576 mm hoch
Bathroom vanity unit, 2 pull-outs,
461 mm deep, 1000 mm wide, 576 mm high

1 x APD 60

Arbeitsplatte APD mit Dekorkante,
38 mm stark, 487 mm tief, 1003 mm breit
Worktop APD with décor edge,
38 mm thick, 487 mm deep, 1003 mm wide

1 x 87726

Aufsatzwaschtisch WB 0517 C 600C,
470 mm tief, 600 mm breit, 144 mm hoch
Surface-mounted hand basin WB 0517 C 600C,
470 mm deep, 600 mm wide, 144 mm high

1 x SPLY 100

Spiegel mit vertikalen LED-Lichtfenstern,
24 mm tief, 1000 mm breit, 850 mm hoch
Mirror with vertical LED light windows,
24 mm deep, 1000 mm wide, 850 mm high

Planleggingsforslag inkluderer ikke kraner, lys, håndtakstillegg eller stikkontakter. Disse må bestilles iht det angitte varenummeret.

Planning suggestions do not include taps, lights, handle surcharges or sockets. These must be ordered in addition to the set item number.

SPEZIFIKATIONEN SPECIFICATIONS

Waschtischgröße Hand basin size

1200 mm

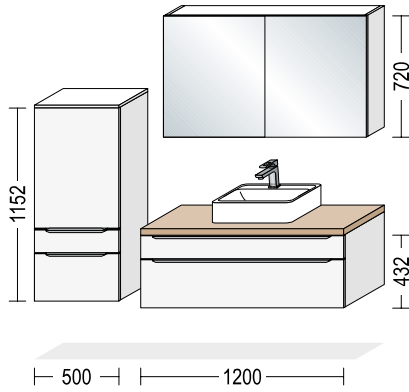

BSET120-001

1 x BMSA 50-115

Badezimmer-Midischrank, 1 Tür, 1 Schubkasten, 1 Auszug, 2 Einlegeböden, 320 mm tief, 500 mm breit, 1152 mm hoch
Bathroom Midi unit, 1 door, 1 drawer, 1 pull-out, 2 shelves, 320 mm deep, 500 mm wide, 1152 mm high

1 x ADB 16-35

Abdeckboden, 16 mm stark, 346 mm tief, 503 mm breit
Top shelf, 16 mm thick, 346 mm deep, 503 mm wide

1 x BWSA 120-43

Badezimmer-Waschtischschrank, 1 Schubkasten, 1 Auszug, 461 mm tief, 1200 mm breit, 432 mm hoch
Bathroom vanity unit, 1 drawer, 1 pull-out, 461 mm deep, 1200 mm wide, 432 mm high

1 x APD 60

Arbeitsplatte APD mit Dekorkante, 38 mm stark, 487 mm tief, 1203 mm breit
Worktop APD with décor edge, 38 mm thick, 487 mm deep, 1203 mm wide

1 x 87726

Aufsatzwaschtisch WB 0517 C 600C, 470 mm tief, 600 mm breit, 144 mm hoch
Surface-mounted hand basin WB 0517 C 600C, 470 mm deep, 600 mm wide, 144 mm high

1 x WBSP 120-02

Spiegelschrank, 2 Spiegeltüren, 2 Glaseinlegeböden, 202 mm tief, 1200 mm breit, 720 mm hoch
Mirrored bathroom cabinet, 2 mirrored doors, 2 glass shelves, 202 mm deep, 1200 mm wide, 720 mm high

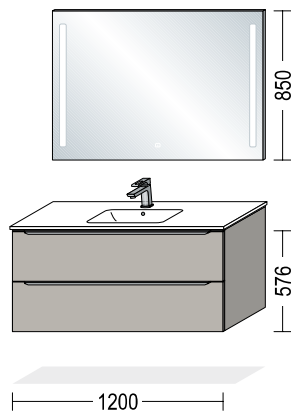

BSET120-002

1 x BWASA 120-58

Badezimmer-Waschtischschrank, 1 Innenblende, 1 Schubkasten mit Auszugsblende, 1 Auszug, 461 mm tief, 1200 mm breit, 576 mm hoch
Bathroom vanity unit, 1 internal panel, 1 drawer with pull-out panel, 1 pull-out, 461 mm deep, 1200 mm wide, 576 mm high

1 x 87712

Waschtisch MEGX 1200C, 492 mm tief, 1214 mm breit, 142 mm hoch
Hand basin MEGX 1200C, 492 mm deep, 1214 mm wide, 142 mm high

1 x SPLV 120

Spiegel mit vertikalen LED-Lichtfenstern, 24 mm tief, 1200 mm breit, 850 mm hoch
Mirror with vertical LED light windows, 24 mm deep, 1200 mm wide, 850 mm high

Planleggingsforslag inkluderer ikke kraner, lys, håndtakstillegg eller stikkontakter. Disse må bestilles iht det angitte varenummeret.

Planning suggestions do not include taps, lights, handle surcharges or sockets. These must be ordered in addition to the set item number.

Waschtischgröße Hand basin size

1200 mm

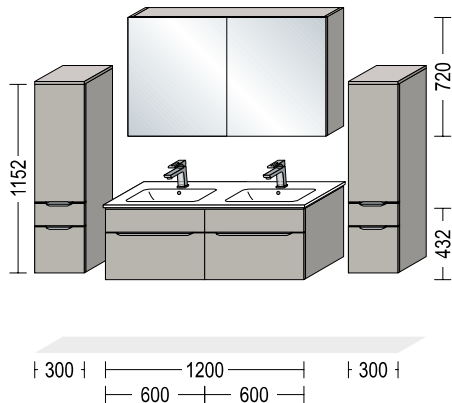

BSET120-003

1 x BMSA 30-115

Badezimmer-Midischrank, 1 Tür, 1 Schubkasten, 1 Auszug, 2 Einlegeböden, 320 mm tief, 300 mm breit, 1152 mm hoch
Bathroom Midi unit, 1 door, 1 drawer, 1 pull-out, 2 shelves, 320 mm deep, 300 mm wide, 1152 mm high

2 x BWA 60-43

Badezimmer-Waschtischschrank, 1 feste Blende, 1 Auszug, 461 mm tief, 600 mm breit, 432 mm hoch
Bathroom vanity unit, 1 fixed panel, 1 pull-out, 461 mm deep, 600 mm wide, 432 mm high

1 x 87722

Doppelwaschtisch MEGX 1200D, 492 mm tief, 1214 mm breit, 142 mm hoch
Double hand basin MEGX 1200D, 492 mm deep, 1214 mm wide, 142 mm high

1 x WBSP 120-02

Spiegelschrank, 2 Spiegeltüren, 2 Glaseinlegeböden, 202 mm tief, 1200 mm breit, 720 mm hoch
Mirrored bathroom cabinet, 2 mirrored doors, 2 glass shelves, 202 mm deep, 1200 mm wide, 720 mm high

1 x BMSA 30-115

Badezimmer-Midischrank, 1 Tür, 1 Schubkasten, 1 Auszug, 2 Einlegeböden, 320 mm tief, 300 mm breit, 1152 mm hoch
Bathroom Midi unit, 1 door, 1 drawer, 1 pull-out, 2 shelves, 320 mm deep, 300 mm wide, 1152 mm high

2 x ADB 16-35

Abdeckboden, 16 mm stark, 346 mm tief, 303 mm breit
Top shelf, 16 mm thick, 346 mm deep, 303 mm wide

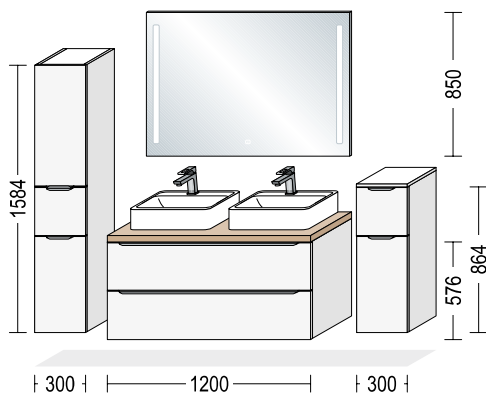

BSET120-004

1 x BMA 30-158

Badezimmer-Midischrank, 1 Tür, 1 Auszug, 1 Tür, 3 Einlegeböden, 320 mm tief, 300 mm breit, 1584 mm hoch
Bathroom Midi unit, 1 door, 1 pull-out, 1 door, 3 shelves, 320 mm deep, 300 mm wide, 1584 mm high

1 x BW2A 120-58

Badezimmer-Waschtischschrank, 2 Auszüge, 461 mm tief, 1200 mm breit, 576 mm hoch
Bathroom vanity unit, 2 pull-outs, 461 mm deep, 1200 mm wide, 576 mm high

1 x APD 60

Arbeitsplatte APD mit Dekorkante, 38 mm stark, 487 mm tief, 1203 mm breit
Worktop APD with décor edge, 38 mm thick, 487 mm deep, 1203 mm wide

2 x 87725

Aufsatzwaschtisch WB 0002 W 520C, 450 mm tief, 519 mm breit, 162 mm hoch
Surface-mounted hand basin WB 0002 W 520C, 450 mm deep, 519 mm wide, 162 mm high

1 x SPLV 120

Spiegel mit vertikalen LED-Lichtfenstern, 24 mm tief, 1200 mm breit, 850 mm hoch
Mirror with vertical LED light windows, 24 mm deep, 1200 mm wide, 850 mm high

1 x BSA 30-86

Badezimmer-Sideboard, 1 Auszug, 1 Tür, 1 Einlegeboden, 320 mm tief, 300 mm breit, 864 mm hoch
Bathroom sideboard, 1 pull-out, 1 door, 1 shelf, 320 mm deep, 300 mm wide, 864 mm high

1 x ADB16-35

Abdeckboden, 16 mm stark, 346 mm tief, 303 mm breit
Top shelf, 16 mm thick, 346 mm deep, 303 mm wide

Planleggingsforslag inkluderer ikke kraner, lys, håndtakstillegg eller stikkontakter. Disse må bestilles iht det angitte varenummeret.

Planning suggestions do not include taps, lights, handle surcharges or sockets. These must be ordered in addition to the set item number.

SPEZIFIKATIONEN SPECIFICATIONS

Waschtischgröße Hand basin size

1500 mm

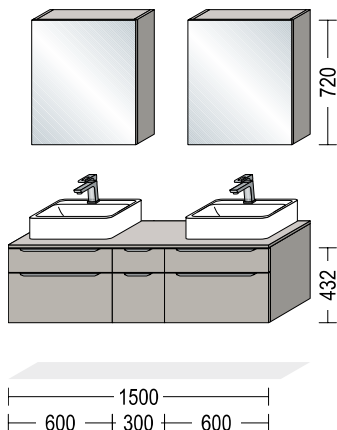
**BSET150-001**

1 x BWSA 60-43

Badezimmer-Waschtischschrank, 1 Schubkasten, 1 Auszug
461 mm tief, 600 mm breit, 432 mm hoch
 Bathroom vanity unit, 1 drawer, 1 pull-out,
 461 mm deep, 600 mm wide, 432 mm high

1 x BUSA 30-43

Badezimmer-Auszugschrank, 1 Schubkasten, 1 Auszug,
461 mm tief, 300 mm breit, 432 mm hoch
 Bathroom Pull-out unit, 1 drawer, 1 pull-out,
 461 mm deep, 300 mm wide, 432 mm high

1 x BWSA 60-43

Badezimmer-Waschtischschrank, 1 Schubkasten, 1 Auszug,
461 mm tief, 600 mm breit, 432 mm hoch
 Bathroom vanity unit, 1 drawer, 1 pull-out,
 461 mm deep, 600 mm wide, 432 mm high

1 x ADB16-59

Abdeckboden, 16 mm stark, 487 mm tief, 1503 mm breit
 Top shelf, 16 mm thick, 487 mm deep, 1503 mm wide

2 x 87726

Aufsatzwaschtisch WB 0517 C 600C,
470 mm tief, 600 mm breit, 144 mm hoch
 Surface-mounted hand basin WB 0517 C 600C,
 470 mm deep, 600 mm wide, 144 mm high

2 x WBSP 60-02

Spiegelschrank, 1 Spiegeltür, 2 Glaseinlegeböden,
202 mm tief, 600 mm breit, 720 mm hoch
 Mirrored bathroom cabinet, 1 mirrored door, 2 glass shelves,
 202 mm deep, 600 mm wide, 720 mm high

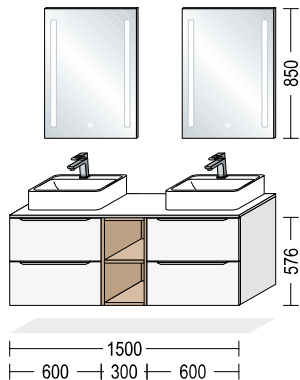
**BSET150-002**

1 x BW2A 60-58

Badezimmer-Waschtischschrank, 2 Auszüge,
461 mm tief, 600 mm breit, 576 mm hoch
 Bathroom vanity unit, 2 pull-outs,
 461 mm deep, 600 mm wide, 576 mm high

1 x BUR 30-58

Badezimmer-Unterschrankregal, 1 fester Boden,
482 mm tief, 300 mm breit, 576 mm hoch
 Bathroom open shelf base unit, 1 fixed shelf,
 482 mm deep, 300 mm wide, 576 mm high

1 x BW2A 60-58

Badezimmer-Waschtischschrank, 2 Auszüge,
461 mm tief, 600 mm breit, 576 mm hoch
 Bathroom vanity unit, 2 pull-outs,
 461 mm deep, 600 mm wide, 576 mm high

1 x ADB16-59

Abdeckboden, 16 mm stark, 487 mm tief, 1503 mm breit
 Top shelf, 16 mm thick, 487 mm deep, 1503 mm wide

2 x 87725

Aufsatzwaschtisch WB 0002 W 520C,
450 mm tief, 519 mm breit, 162 mm hoch
 Surface-mounted hand basin WB 0002 W 520C,
 450 mm deep, 519 mm wide, 162 mm high

2 x SPLV 60

Spiegel mit vertikalen LED-Lichtfenstern,
24 mm tief, 600 mm breit, 850 mm hoch
 Mirror with vertical LED light windows,
 24 mm deep, 600 mm wide, 850 mm high

Planleggingsforslag inkluderer ikke kræner, lys, håndtakstillegg eller stikkontakter. Disse må bestilles iht det angitte varenummeret.

Planning suggestions do not include taps, lights, handle surcharges or sockets. These must be ordered in addition to the set item number.

SPEZIFIKATIONEN SPECIFICATIONS

Håndtakløs

Waschtischgröße Hand basin size

600 mm

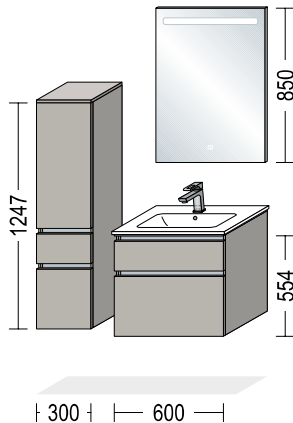

NBSET60-001

1 x NBMSA 30-125

Badezimmer-Midischrank, 1 Tür, 1 Schubkasten, 1 Auszug, 2 Einlegeböden, 320 mm tief, 300 mm breit, 1247 mm hoch
Bathroom Midi unit, 1 door, 1 drawer, 1 pull-out, 2 shelves, 320 mm deep, 300 mm wide, 1247 mm high

1 x ADB 16-35

Abdeckboden, 16 mm stark, 343 mm tief, 303 mm breit
Top shelf, 16 mm thick, 343 mm deep, 303 mm wide

1 x NBWA 60-55

Badezimmer-Waschtischschrank, 1 feste Blende, 1 Auszug, 461 mm tief, 600 mm breit, 554 mm hoch
Bathroom vanity unit, 1 fixed panel, 1 pull-out, 461 mm deep, 600 mm wide, 554 mm high

1 x 87706

Waschtisch MEGX 600C, 492 mm tief, 614 mm breit, 142 mm hoch
Hand basin MEGX 600C, 492 mm deep, 614 mm wide, 142 mm high

1 x SPLH 60

Spiegel mit horizontalem LED-Lichtfenster, 24 mm tief, 600 mm breit, 850 mm hoch
Mirror with horizontal LED light window, 24 mm deep, 600 mm wide, 850 mm high

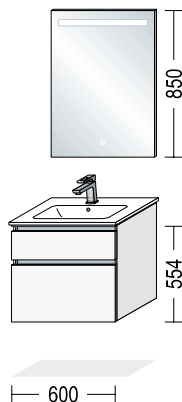

NBSET60-002

1 x NBWA 60-55

Badezimmer-Waschtischschrank, 1 feste Blende, 1 Auszug, 461 mm tief, 600 mm breit, 554 mm hoch
Bathroom vanity unit, 1 fixed panel, 1 pull-out, 461 mm deep, 600 mm wide, 554 mm high

1 x 87706

Waschtisch MEGX 600C, 492 mm tief, 614 mm breit, 142 mm hoch
Hand basin MEGX 600C, 492 mm deep, 614 mm wide, 142 mm high

1 x SPLH 60

Spiegel mit horizontalem LED-Lichtfenster, 24 mm tief, 600 mm breit, 850 mm hoch
Mirror with horizontal LED light window, 24 mm deep, 600 mm wide, 850 mm high

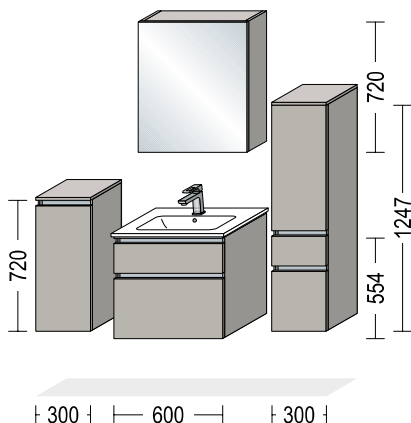

NBSET60-003

1 x NBS 30-72

Badezimmer-Sideboard, 1 Tür, 2 Einlegeböden, 320 mm tief, 300 mm breit, 720 mm hoch
Bathroom sideboard, 1 door, 2 shelves, 320 mm deep, 300 mm wide, 720 mm high

1 x ADB 16-35

Abdeckboden, 16 mm stark, 343 mm tief, 303 mm breit
Top shelf, 16 mm thick, 343 mm deep, 303 mm wide

1 x NBWA 60-55

Badezimmer-Waschtischschrank, 1 feste Blende, 1 Auszug, 461 mm tief, 600 mm breit, 554 mm hoch
Bathroom vanity unit, 1 fixed panel, 1 pull-out, 461 mm deep, 600 mm wide, 554 mm high

1 x 87706

Waschtisch MEGX 600C, 492 mm tief, 614 mm breit, 142 mm hoch
Hand basin MEGX 600C, 492 mm deep, 614 mm wide, 142 mm high

1 x WBSP 60-02

Spiegelschrank, 1 Spiegeltür, 2 Glaseinlegeböden, 202 mm tief, 600 mm breit, 720 mm hoch
Mirrored bathroom cabinet, 1 mirrored door, 2 glass shelves, 202 mm deep, 600 mm wide, 720 mm high

1 x NBMSA 30-125

Badezimmer-Midischrank, 1 Tür, 1 Schubkasten, 1 Auszug, 2 Einlegeböden, 320 mm tief, 300 mm breit, 1247 mm hoch
Bathroom Midi unit, 1 door, 1 drawer, 1 pull-out, 2 shelves, 320 mm deep, 300 mm wide, 1247 mm high

1 x ADB 16-35

Abdeckboden, 16 mm stark, 343 mm tief, 303 mm breit
Top shelf, 16 mm thick, 343 mm deep, 303 mm wide

Planleggingsforslag inkluderer ikke kraner, lys eller stikkontakter. Disse må bestilles iht det angitte varenummeret.

The planning suggestions do not include taps, lights or sockets. These must be ordered in addition to the set item number.

SPEZIFIKATIONEN SPECIFICATIONS

Håndtakløs

Waschtischgröße Hand basin size

800 mm

60-61

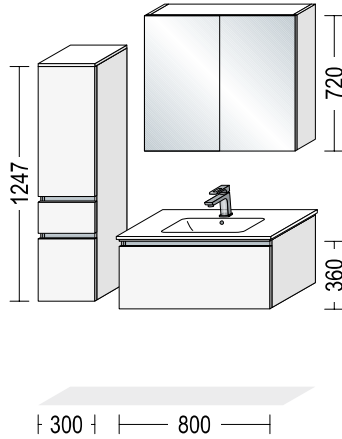

NBSET80-001

1 x NBMSA 30-125

Badezimmer-Midischrank, 1 Tür, 1 Schubkasten, 1 Auszug, 2 Einlegeböden, 320 mm tief, 300 mm breit, 1247 mm hoch
Bathroom Midi unit, 1 door, 1 drawer, 1 pull-out, 2 shelves, 320 mm deep, 300 mm wide, 1247 mm high

1 x ADB16-35

Abdeckboden, 16 mm stark, 343 mm tief, 303 mm breit
Top shelf, 16 mm thick, 343 mm deep, 303 mm wide

1 x NBWBA 80-36

Badezimmer-Waschtischschrank, 1 Innenblende, 1 Auszug, 461 mm tief, 800 mm breit, 360 mm hoch
Bathroom vanity unit, 1 internal panel, 1 pull-out, 461 mm deep, 800 mm wide, 360 mm high

1 x 87708

Waschtisch MEGX 800C, 492 mm tief, 814 mm breit, 142 mm hoch
Hand basin MEGX 800C, 492 mm deep, 814 mm wide, 142 mm high

1 x WBSP 80-02

Spiegelschrank, 2 Spiegeltüren, 2 Glaseinlegeböden, 202 mm tief, 800 mm breit, 720 mm hoch
Mirrored bathroom cabinet, 2 mirrored doors, 2 glass shelves, 202 mm deep, 800 mm wide, 720 mm high

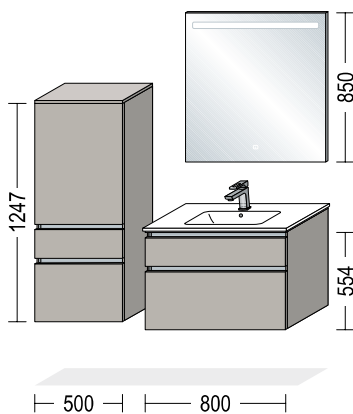

NBSET80-002

1 x NBMSA 50-125

Badezimmer-Midischrank, 1 Tür, 1 Schubkasten, 1 Auszug, 2 Einlegeböden, 320 mm tief, 500 mm breit, 1247 mm hoch
Bathroom Midi unit, 1 door, 1 drawer, 1 pull-out, 2 shelves, 320 mm deep, 500 mm wide, 1247 mm high

1 x ADB16-35

Abdeckboden, 16 mm stark, 343 mm tief, 503 mm breit
Top shelf, 16 mm thick, 343 mm deep, 503 mm wide

1 x NBWA 80-55

Badezimmer-Waschtischschrank, 1 feste Blende, 1 Auszug, 461 mm tief, 800 mm breit, 554 mm hoch
Bathroom vanity unit, 1 fixed panel, 1 pull-out, 461 mm deep, 800 mm wide, 554 mm high

1 x 87708

Waschtisch MEGX 800C, 492 mm tief, 814 mm breit, 142 mm hoch
Hand basin MEGX 800C, 492 mm deep, 814 mm wide, 142 mm high

1 x SPLH 80

Spiegel mit horizontalem LED-Lichtfenster, 24 mm tief, 800 mm breit, 850 mm hoch
Mirror with horizontal LED light window, 24 mm deep, 800 mm wide, 850 mm high

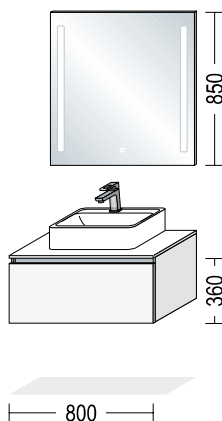

NBSET80-003

1 x NBWA 80-36

Badezimmer-Waschtischschrank, 461 mm tief, 800 mm breit, 360 mm hoch
Bathroom vanity unit, 461 mm deep, 800 mm wide, 360 mm high

1 x ADB16-59

Abdeckboden, 16 mm stark, 484 mm tief, 803 mm breit
Top shelf, 16 mm thick, 484 mm deep, 803 mm wide

1 x 87726

Aufsatzwaschtisch WB 0517 C 600C, 470 mm tief, 600 mm breit, 144 mm hoch
Surface-mounted hand basin WB 0517 C 600C, 470 mm deep, 600 mm wide, 144 mm high

1 x SPLV 80

Spiegel mit vertikalen LED-Lichtfenstern, 24 mm tief, 800 mm breit, 850 mm hoch
Mirror with vertical LED light windows, 24 mm deep, 800 mm wide, 850 mm high

Planleggingsforslag inkluderer ikke kraner, lys eller stikkontakter. Disse må bestilles iht det angitte varenummeret.

The planning suggestions do not include taps, lights or sockets. These must be ordered in addition to the set item number.

Waschtischgröße Hand basin size

1000 mm

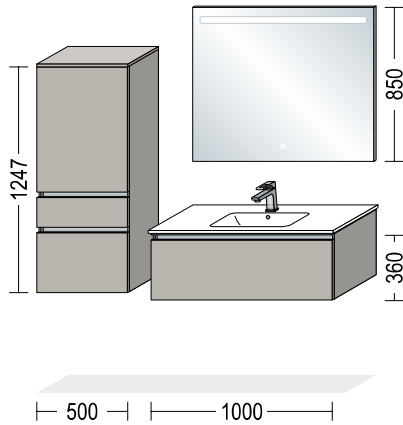

NBSET100-001

1 x NBMSA 50-125

Badezimmer-Midischrank, 1 Tür, 1 Schubkasten, 1 Auszug, 2 Einlegeböden, 320 mm tief, 500 mm breit, 1247 mm hoch
Bathroom Midi unit, 1 door, 1 drawer, 1 pull-out, 2 shelves, 320 mm deep, 500 mm wide, 1247 mm high

1 x ADB16-35

Abdeckboden, 16 mm stark, 343 mm tief, 503 mm breit
Top shelf, 16 mm thick, 343 mm deep, 503 mm wide

1 x NBWBA 100-36

Badezimmer-Waschtischschrank, 1 Innenblende, 1 Auszug, 461 mm tief, 1000 mm breit, 360 mm hoch
Bathroom vanity unit, 1 internal panel, 1 pull-out, 461 mm deep, 1000 mm wide, 360 mm high

1 x 87710

Waschtisch MEGX 1000C, 492 mm tief, 1014 mm breit, 142 mm hoch
Hand basin MEGX 1000C, 492 mm deep, 1014 mm wide, 142 mm high

1 x SPLH 100

Spiegel mit horizontalem LED-Lichtfenster, 24 mm tief, 1000 mm breit, 850 mm hoch
Mirror with horizontal LED light window, 24 mm deep, 1000 mm wide, 850 mm high

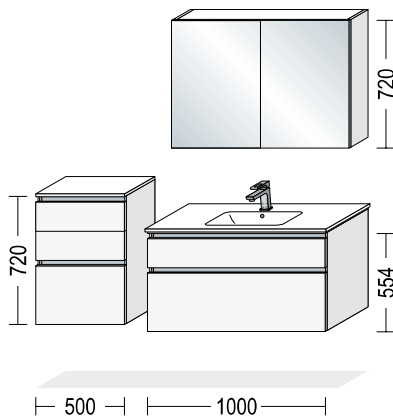

NBSET100-002

1 x NBS2SA 50-72

Badezimmer-Sideboard, 2 Schubkästen, 1 Auszug, 320 mm tief, 500 mm breit, 720 mm hoch
Bathroom sideboard, 2 drawers, 1 pull-out, 320 mm deep, 500 mm wide, 720 mm high

1 x ADB16-35

Abdeckboden, 16 mm stark, 343 mm tief, 503 mm breit
Top shelf, 16 mm thick, 343 mm deep, 503 mm wide

1 x NBWA 100-55

Badezimmer-Waschtischschrank, 1 feste Blende, 1 Auszug, 461 mm tief, 1000 mm breit, 554 mm hoch
Bathroom vanity unit, 1 fixed panel, 1 pull-out, 461 mm deep, 1000 mm wide, 554 mm high

1 x 87710

Waschtisch MEGX 1000C, 492 mm tief, 1014 mm breit, 142 mm hoch
Hand basin MEGX 1000C, 492 mm deep, 1014 mm wide, 142 mm high

1 x WBSP 100-02

Spiegelschrank, 2 Spiegeltüren, 2 Gleaseinlegeböden, 202 mm tief, 1000 mm breit, 720 mm hoch
Mirrored bathroom cabinet, 2 mirrored doors, 2 glass shelves, 202 mm deep, 1000 mm wide, 720 mm high

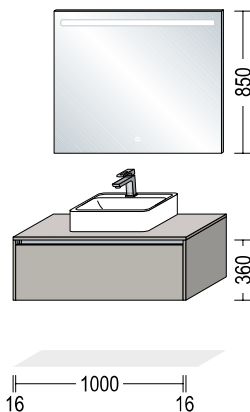

NBSET100-003

1 x NBWA 100-36

Badezimmer-Waschtischschrank, 1 Auszug, 461 mm tief, 1000 mm breit, 360 mm hoch
Bathroom vanity unit, 1 pull-out, 461 mm deep, 1000 mm wide, 360 mm high

2 x NBWU 16-36

Abschlusswangen, 16 mm stark, 360 mm hoch, 482 mm tief
End uprights, 16 mm thick, 360 mm high, 482 mm deep

1 x ADB16-59

Abdeckboden, 16 mm stark, 484 mm tief, 1035 mm breit
Top shelf, 16 mm thick, 484 mm deep, 1035 mm wide

1 x 87726

Aufsatzwaschtisch WB 0517 C 600C, 470 mm tief, 600 mm breit, 144 mm hoch
Surface-mounted hand basin WB 0517 C 600C, 470 mm deep, 600 mm wide, 144 mm high

1 x SPLH 100

Spiegel mit horizontalem LED-Lichtfenster, 24 mm tief, 1000 mm breit, 850 mm hoch
Mirror with horizontal LED light window, 24 mm deep, 1000 mm wide, 850 mm high

Planleggingsforslag inkluderer ikke kranner, lys eller stikkontakter. Disse må bestilles iht det angitte varenummeret.

The planning suggestions do not include taps, lights or sockets. These must be ordered in addition to the set item number.

SPEZIFIKATIONEN SPECIFICATIONS

Håndtakløs

Waschtischgröße Hand basin size

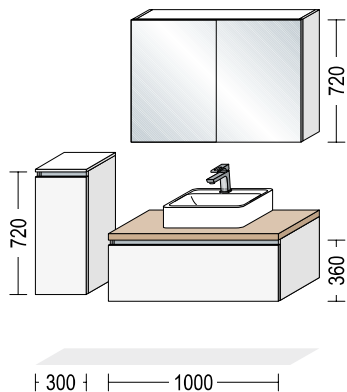
1000 mm**NBSET100-004**

1 x NBS 30-72

Badezimmer-Sideboard, 1 Tür, 2 Einlegeböden,
320 mm tief, 300 mm breit, 720 mm hoch
Bathroom sideboard, 1 door, 2 shelves,
320 mm deep, 300 mm wide, 720 mm high

1 x ADB16-35

Abdeckboden, 16 mm stark, 343 mm tief, 303 mm breit
Top shelf, 16 mm thick, 343 mm deep, 303 mm wide

1 x NBWA 100-36

Badezimmer-Waschtischschrank, 1 Auszug,
461 mm tief, 1000 mm breit, 360 mm hoch
Bathroom vanity unit, 1 pull-out,
461 mm deep, 1000 mm wide, 360 mm high

1 x APD 60

Arbeitsplatte APD mit Dekorkante,
38 mm stark, 485 mm tief, 1003 mm breit
Worktop APD with décor edge,
38 mm thick, 485 mm deep, 1003 mm wide

1 x 87725

Aufsatzwaschtisch WB 0002 W 520C,
450 mm tief, 519 mm breit, 162 mm hoch
Surface-mounted hand basin WB 0002 W 520C,
450 mm deep, 519 mm wide, 162 mm high

1 x WBSP 100-02

Spiegelschrank, 2 Spiegeltüren, 2 Glaseinlegeböden,
202 mm tief, 1000 mm breit, 720 mm hoch
Mirrored bathroom cabinet, 2 mirrored doors, 2 glass shelves,
202 mm deep, 1000 mm wide, 720 mm high

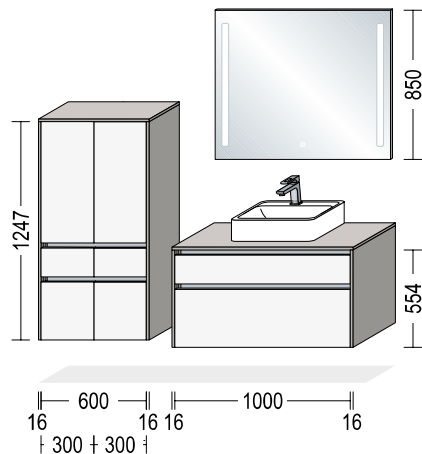
**NBSET100-005**

2 x NBMSA 30-125

Badezimmer-Midischrank, 1 Tür, 1 Schubkasten, 1 Auszug,
2 Einlegeböden, 320 mm tief, 300 mm breit, 1247 mm hoch
Bathroom Midi unit, 1 door, 1 drawer, 1 pull-out, 2 shelves,
320 mm deep, 300 mm wide, 1247 mm high

1 x ADB16-35

Abdeckboden, 16 mm stark, 343 mm tief, 635 mm breit
Top shelf, 16 mm thick, 343 mm deep, 635 mm wide

2 x NBMW16-125

Abschlusswangen, 16 mm stark, 341 mm tief, 1247 mm breit
End uprights, 16 mm thick, 341 mm deep, 1247 mm wide

1 x NBWSA 100-55

Badezimmer-Waschtischschrank, 1 Schubkasten, 1 Auszug,
461 mm tief, 1000 mm breit, 554 mm hoch
Bathroom vanity unit, 1 drawer, 1 pull-out,
461 mm deep, 1000 mm wide, 554 mm high

1 x ADB16-59

Abdeckboden, 16 mm stark, 484 mm tief, 1035 mm breit
Top shelf, 16 mm thick, 484 mm deep, 1035 mm wide

1 x 87726

Aufsatzwaschtisch WB 0517 C 600C,
470 mm tief, 600 mm breit, 144 mm hoch
Surface-mounted hand basin WB 0517 C 600C,
470 mm deep, 600 mm wide, 144 mm high

2 x NBW16-55

Abschlusswangen, 16 mm stark, 482 mm tief, 554 mm hoch
End uprights, 16 mm thick, 482 mm deep, 554 mm high

1 x SPLV 100

Spiegel mit vertikalen LED-Lichtfenstern,
24 mm tief, 1000 mm breit, 850 mm hoch
Mirror with vertical LED light windows,
24 mm deep, 1000 mm wide, 850 mm high

Planleggingsforslag inkluderer ikke kræner, lys eller stikkontakter. Disse må bestilles iht det angitte varenummeret.

The planning suggestions do not include taps, lights or sockets. These must be ordered in addition to the set item number.

Waschtischgröße Hand basin size

1200 mm

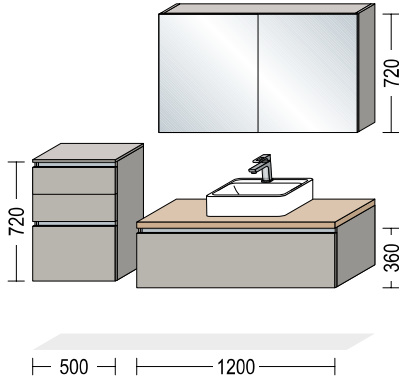

NBSET120-001

1 x NBS2SA 50-72

Badezimmer-Sideboard, 2 Schubkästen, 1 Auszug, 320 mm tief, 500 mm breit, 720 mm hoch
Bathroom sideboard, 2 drawers, 1 pull-out, 320 mm deep, 500 mm wide, 720 mm high

1 x ADB16-35

Abdeckboden, 16 mm stark, 343 mm tief, 503 mm breit
Top shelf, 16 mm thick, 343 mm deep, 503 mm wide

1 x NBWA 120-36

Badezimmer-Waschtischschrank, 1 Auszug, 461 mm tief, 1200 mm breit, 360 mm hoch
Bathroom vanity unit, 1 pull-out, 461 mm deep, 1200 mm wide, 360 mm high

1 x APD 60

Arbeitsplatte APD mit Dekorkante, 38 mm stark, 485 mm tief, 1203 mm breit
Worktop APD with décor edge, 38 mm thick, 485 mm deep, 1203 mm wide

1 x 87726

Aufsatzwaschtisch WB 0517 C 600C, 470 mm tief, 600 mm breit, 144 mm hoch
Surface-mounted hand basin WB 0517 C 600C, 470 mm deep, 600 mm wide, 144 mm high

1 x WBSP 120-02

Spiegelschrank, 2 Spiegeltüren, 2 Glaseinlegeböden, 202 mm tief, 1200 mm breit, 720 mm hoch
Mirrored bathroom cabinet, 2 mirrored doors, 2 glass shelves, 202 mm deep, 1200 mm wide, 720 mm high

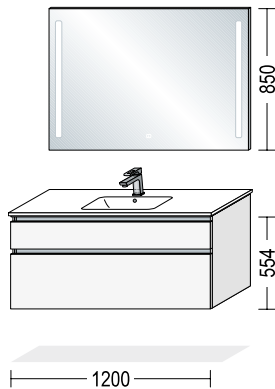

NBSET120-002

1 x NBWA 120-55

Badezimmer-Waschtischschrank, 1 feste Blende, 1 Auszug, 461 mm tief, 1200 mm breit, 554 mm hoch
Bathroom vanity unit, 1 fixed panel, 1 pull-out, 461 mm deep, 1200 mm wide, 554 mm high

1 x 87712

Waschtisch MEGX 1200C, 492 mm tief, 1214 mm breit, 142 mm hoch
Hand basin MEGX 1200C, 492 mm deep, 1214 mm wide, 142 mm high

1 x SPLV 120

Spiegel mit vertikalen LED-Lichtfenstern, 24 mm tief, 1200 mm breit, 850 mm hoch
Mirror with vertical LED light windows, 24 mm deep, 1200 mm wide, 850 mm high

Planleggingsforslag inkluderer ikke kranner, lys eller stikkontakter. Disse må bestilles iht det angitte varenummeret.

The planning suggestions do not include taps, lights or sockets. These must be ordered in addition to the set item number.

SPEZIFIKATIONEN SPECIFICATIONS

Håndtakløst

Waschtischgröße Hand basin size

1200 mm

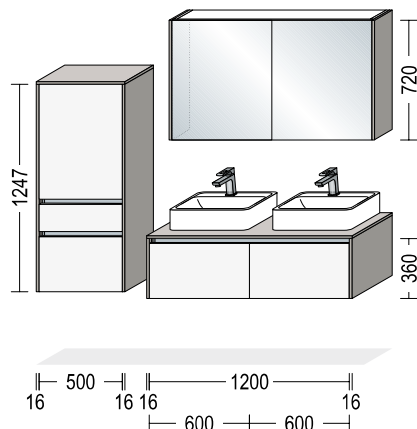
**NBSET120-003**

1 x NBMSA 50-125

Badezimmer-Midischrank, 1 Tür, 1 Schubkasten, 1 Auszug, 2 Einlegeböden, 320 mm tief, 500 mm breit, 1247 mm hoch
Bathroom Midi unit, 1 door, 1 drawer, 1 pull-out, 2 shelves, 320 mm deep, 500 mm wide, 1247 mm high

2 x NBMW16-125

Abschlusswangen, 16 mm stark, 341 mm tief, 1247 mm hoch
End uprights, 16 mm thick, 341 mm deep, 1247 mm high

1 x ADB16-35

Abdeckboden, 16 mm stark, 343 mm tief, 535 mm breit
Top shelf, 16 mm thick, 343 mm deep, 535 mm wide

2 x NBWA 60-36

Badezimmer-Waschtischschrank, 1 Auszug, 461 mm tief, 600 mm breit, 360 mm hoch
Bathroom vanity unit, 1 pull-out, 461 mm deep, 600 mm wide, 360 mm high

2 x NBWU16-36

Abschlusswangen, 16 mm stark, 482 mm tief, 360 mm hoch
End uprights, 16 mm thick, 482 mm deep, 360 mm high

1 x ADB16-59

Abdeckboden, 16 mm stark, 484 mm tief, 1235 mm breit
Top shelf, 16 mm thick, 484 mm deep, 1235 mm wide

2 x 87725

Aufsatzwaschtisch WB 0002 W 520C, 450 mm tief, 519 mm breit, 162 mm hoch
Surface-mounted hand basin WB 0002 W 520C, 450 mm deep, 519 mm wide, 162 mm high

1 x WBSP 120-02

Spiegelschrank, 2 Spiegeltüren, 2 Glaseinlegeböden, 202 mm tief, 1200 mm breit, 720 mm hoch
Mirrored bathroom cabinet, 2 mirrored doors, 2 glass shelves, 202 mm deep, 1200 mm wide, 720 mm high

2 x WWBSP-72

Abschlusswange für Spiegelschrank, 16 mm stark, 213 mm tief, 720 mm hoch
Upright at end of run for mirrored bathroom cabinet, 16 mm thick, 213 mm deep, 720 mm high

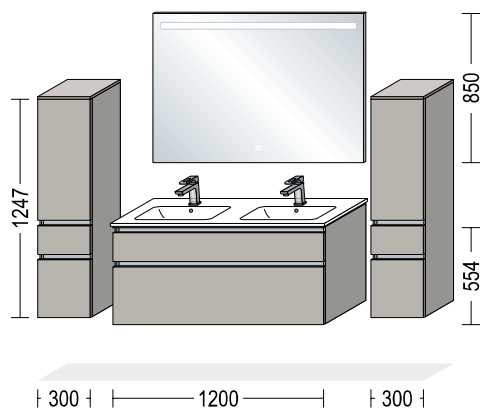
**NBSET120-004**

1 x NBMSA 30-125

Badezimmer-Midischrank, 1 Tür, 1 Schubkasten, 1 Auszug, 2 Einlegeböden, 320 mm tief, 300 mm breit, 1247 mm hoch
Bathroom Midi unit, 1 door, 1 drawer, 1 pull-out, 2 shelves, 320 mm deep, 300 mm wide, 1247 mm high

1 x ADB16-35

Abdeckboden, 16 mm stark, 343 mm tief, 303 mm breit
Top shelf, 16 mm thick, 343 mm deep, 303 mm wide

1 x NBWA 120-55

Badezimmer-Waschtischschrank, 1 feste Blende, 1 Auszug, 461 mm tief, 1200 mm breit, 554 mm hoch
Bathroom vanity unit, 1 fixed panel, 1 pull-out, 461 mm deep, 1200 mm wide, 554 mm high

1 x 87722

Doppelwaschtisch MEGX 1200D, 492 mm tief, 1214 mm breit, 142 mm hoch
Double hand basin MEGX 1200D, 492 mm deep, 1214 mm wide, 142 mm high

1 x SPLH 120

Spiegel mit horizontalem LED-Lichtfenster, 24 mm tief, 1200 mm breit, 850 mm hoch
Mirror with horizontal LED light window, 24 mm deep, 1200 mm wide, 850 mm high

1 x NBMSA 30-125

Badezimmer-Midischrank, 1 Tür, 1 Schubkasten, 1 Auszug, 2 Einlegeböden, 320 mm tief, 300 mm breit, 1247 mm hoch
Bathroom Midi unit, 1 door, 1 drawer, 1 pull-out, 2 shelves, 320 mm deep, 300 mm wide, 1247 mm high

1 x ADB16-35

Abdeckboden, 16 mm stark, 343 mm tief, 303 mm breit
Top shelf, 16 mm thick, 343 mm deep, 303 mm wide

Planleggingsforslag inkluderer ikke kraner, lys eller stikkontakter. Disse må bestilles iht det angitte varenummeret.

The planning suggestions do not include taps, lights or sockets. These must be ordered in addition to the set item number.

Waschtischgröße Hand basin size

1500 mm

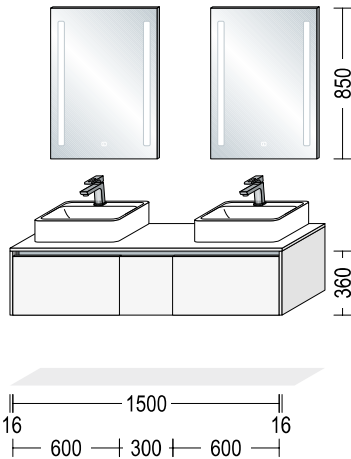

NBSET150-001

1 x NBWA 60-36

Badezimmer-Waschtischschrank, 1 Auszug, 461 mm tief, 600 mm breit, 360 mm hoch
Bathroom vanity unit, 1 pull-out, 461 mm deep, 600 mm wide, 360 mm high

1 x NBUA 30-36

Badezimmer-Auszugschrank, 1 Auszug, 461 mm tief, 300 mm breit, 360 mm hoch
Bathroom pull-out unit, 1 pull-out, 461 mm deep, 300 mm wide, 360 mm high

1 x NBWA 60-36

Badezimmer-Waschtischschrank, 1 Auszug, 461 mm tief, 600 mm breit, 360 mm hoch
Bathroom vanity unit, 1 pull-out, 461 mm deep, 600 mm wide, 360 mm high

1 x ADB16-59

Abdeckboden, 16 mm stark, 484 mm tief, 1535 mm breit
Top shelf, 16 mm thick, 484 mm deep, 1535 mm wide

2 x 87725

Aufsatzwaschtisch WB 0002 W 520C, 450 mm tief, 519 mm breit, 162 mm hoch
Surface-mounted hand basin WB 0002 W 520C, 450 mm deep, 519 mm wide, 162 mm high

2 x NBWU16-36

Abschlusswangen, 16 mm stark, 482 mm tief, 360 mm hoch
End uprights, 16 mm thick, 482 mm deep, 360 mm high

2 x SPLV 60

Spiegel mit vertikalen LED-Lichtfenstern, 24 mm tief, 600 mm breit, 850 mm hoch
Mirror with vertical LED light windows, 24 mm deep, 600 mm wide, 850 mm high

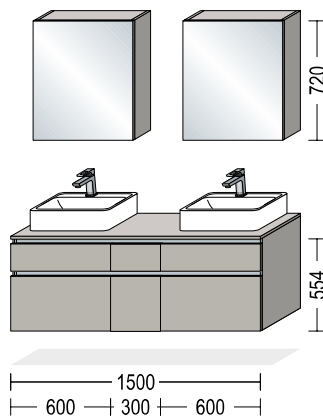

NBSET150-002

1 x NBWSA 60-55

Badezimmer-Waschtischschrank, 1 Schubkasten, 1 Auszug, 461 mm tief, 600 mm breit, 554 mm hoch
Bathroom vanity unit, 1 drawer, 1 pull-out, 461 mm deep, 600 mm wide, 554 mm high

1 x NBUSA 30-55

Badezimmer-Auszugschrank, 1 Schubkasten, 1 Auszug, 461 mm tief, 300 mm breit, 554 mm hoch
Bathroom pull-out unit, 1 drawer, 1 pull-out, 461 mm deep, 300 mm wide, 554 mm high

1 x NBWSA 60-55

Badezimmer-Waschtischschrank, 1 Schubkasten, 1 Auszug, 461 mm tief, 600 mm breit, 554 mm hoch
Bathroom vanity unit, 1 drawer, 1 pull-out, 461 mm deep, 600 mm wide, 554 mm high

2 x 87726

Aufsatzwaschtisch WB 0517 C 600C, 470 mm tief, 600 mm breit, 144 mm hoch
Surface-mounted hand basin WB 0517 C 600C, 470 mm deep, 600 mm wide, 144 mm high

1 x ADB16-59

Abdeckboden, 16 mm stark, 484 mm tief, 1503 mm breit
Top shelf, 16 mm thick, 484 mm deep, 1503 mm wide

2 x WBSP 60-02

Spiegelschrank, 1 Spiegeltür, 2 Glaseinlegeböden, 202 mm tief, 600 mm breit, 720 mm hoch
Mirrored bathroom cabinet, 1 mirrored door, 2 glass shelves, 202 mm deep, 600 mm wide, 720 mm high

Planleggingsforslag inkluderer ikke kranner, lys eller stikkontakter. Disse må bestilles iht det angitte varenummeret.

The planning suggestions do not include taps, lights or sockets. These must be ordered in addition to the set item number.

DETALJER AV INTERIØRINNMAT OG TILBEHØR*

DETAILS OF INTERIOR FITTINGS AND ACCESSORIES*



Spiegelschrank mit Doppelsteckdose

Mirrored cabinet with double socket



Einbau-Abfallsammler Seperato

Built-in waste collector Seperato



Siphon-Aussparung

Siphon cut-out



3-teiliges Utensilien-System zur Abdeckung der Siphon-Aussparung

3-part utensil system to cover the siphon cut-out



Handtuchhalter zur Planung auf 16 mm starken Wänden

Towel rail for planning on 16 mm thick upright panels



Wandkonsole aus Stahl, lieferbar in Schwarz und Chrom Glanz

Wall bracket in steel, available in black and chrome gloss

* Se salgshåndbok for vårt omfattende utvalg av interiørbeslag og tilbehør.

*Please refer to our sales manual for our extensive range of interior fittings and accessories.

FRONTER FRONTS



SPEED 244 PG 1
Alpinweiß

SPEED 244 PG 1
Alpine white



SPEED 239 PG 1
Weiß softmatt

SPEED 239 PG 1
White softmatt



SPEED 206 PG 1
Magnolia softmatt

SPEED 206 PG 1
Ivory softmatt



SPEED 259 PG 1
Seidengrau

SPEED 259 PG 1
Satin grey



SPEED 288 PG 1
Schwarzbeton Nachbildung

SPEED 288 PG 1
Black Concrete reproduction



SPEED 262 PG 1
Eiche Virginia Nachbildung

SPEED 262 PG 1
Virginia oak reproduction



LASER 427 PG 2
Alpinweiß

LASER 427 PG 2
Alpine white



LASER 416 PG 2
Weiß

LASER 416 PG 2
White



LASER 418 PG 2
Magnolia matt

LASER 418 PG 2
Ivory matt



LASER 417 PG 2
Seidengrau

LASER 417 PG 2
Satin grey



LASER 415 PG 2
Sand

LASER 415 PG 2
Sand



RIO 666 PG 2
Eiche Virginia Nachbildung

RIO 666 PG 2
Virginia oak reproduction



RIVA 891 PG 2
Weißbeton Nachbildung

RIVA 891 PG 2
White Concrete reproduction

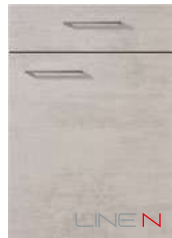

RIVA 892 PG 2
Beton grau Nachbildung

RIVA 892 PG 2
Concrete grey reproduction



RIVA 889 PG 2
Beton schiefergrau Nachbildung

RIVA 889 PG 2
Concrete Slate Grey reproduction



RIVA 893 PG 2
Eiche San Remo Nachbildung

RIVA 893 PG 2
Sanremo oak reproduction



RIVA 887 PG 2
Eiche Somerset Nachbildung

RIVA 887 PG 2
Somerset oak reproduction



STRUCTURA 401 PG 3
Eiche Halifax Nachbildung

STRUCTURA 401 PG 3
Sherwood oak reproduction



STRUCTURA 402 PG 3
Eiche Havana Nachbildung

STRUCTURA 402 PG 3
Havana oak reproduction



STRUCTURA 405 PG 3
Eiche Sierra Nachbildung

STRUCTURA 405 PG 3
Sierra oak reproduction



STRUCTURA 403 PG 3
Eiche Nero Nachbildung

STRUCTURA 403 PG 3
Nero oak reproduction



TOUCH 332 PG 3
Lacklaminat, Alpinweiß supermatt

TOUCH 332 PG 3
Lacquered laminate, alpine white supermatt



TOUCH 336 PG 3
Lacklaminat, Magnolia supermatt

TOUCH 336 PG 3
Lacquered laminate, ivory supermatt



TOUCH 338 PG 3
Lacklaminat, Seidengrau supermatt

TOUCH 338 PG 3
Lacquered laminate, satin grey supermatt

Fronter merket med LINE N, er også tilgjengelig i håndtakløse badrom.
Fronter marked with the LINE N logo are also available as handleless bathrooms.

FRONTER FRONTS

68-69



TOUCH 341 PG 3
Lacklaminat,
Steingrau supermatt

TOUCH 341 PG 3
Lacquered laminate,
stone grey supermatt



TOUCH 337 PG 3
Lacklaminat,
Aqua supermatt

TOUCH 337 PG 3
Lacquered laminate,
aqua supermatt



TOUCH 334 PG 3
Lacklaminat,
Schieferrau supermatt

TOUCH 334 PG 3
Lacquered laminate,
slate grey supermatt

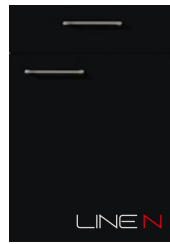

TOUCH 340 PG 3
Lacklaminat,
Schwarz supermatt

TOUCH 340 PG 3
Lacquered laminate,
black supermatt



FLASH 503 PG 3
Lacklaminat,
Alpinweiß Hochglanz

FLASH 503 PG 3
Lacquered laminate,
alpine white high gloss



FLASH 450 PG 3
Lacklaminat,
Weiß Hochglanz

FLASH 450 PG 3
Lacquered laminate,
white high gloss

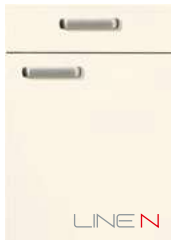

FLASH 452 PG 3
Lacklaminat,
Magnolia Hochglanz

FLASH 452 PG 3
Lacquered laminate,
ivory high gloss



FLASH 455 PG 3
Lacklaminat,
Seidengrau Hochglanz

FLASH 455 PG 3
Lacquered laminate,
satin grey high gloss



FLASH 453 PG 3
Lacklaminat,
Schieferrau Hochglanz

FLASH 453 PG 3
Lacquered laminate,
slate grey high gloss



EASYTOUCH 961 PG 4
Lacklaminat,
Grafit schwarz ultramatt

EASYTOUCH 961 PG 4
Lacquered laminate,
graphite black ultra matt



EASYTOUCH 963 PG 4
Lacklaminat,
Rostrot ultramatt

EASYTOUCH 963 PG 4
Lacquered laminate,
rust red ultra matt



STONEART 304 PG 4
Schiefer steingrau
Nachbildung

STONEART 304 PG 4
Stone grey slate
reproduction



STONEART 303 PG 4
Grauschiefer
Nachbildung

STONEART 303 PG 4
Grey slate
reproduction



INOX 216 PG 4
Lacklaminat, Stahl
gebürstet Nachbildung

INOX 216 PG 4
Lacquered laminate,
brushed steel
reproduction



FASHION 168 PG 4
Lack,
Alpinweiß matt

FASHION 168 PG 4
Lacquer,
honed alpine white



FASHION 173 PG 4
Lack,
Weiß matt

FASHION 173 PG 4
Lacquer,
honed white



FASHION 175 PG 4
Lack,
Magnolia matt

FASHION 175 PG 4
Lacquer,
honed ivory



FASHION 171 PG 4
Lack,
Seidengrau matt

FASHION 171 PG 4
Lacquer,
honed satin grey



FASHION 165 PG 4
Lack,
Steingrau matt

FASHION 165 PG 4
Lacquer,
honed stone grey



FOCUS 470 PG 4
Lack, Alpinweiß
Ultra-Hochglanz

FOCUS 470 PG 4
Lacquer, alpine white
ultra high gloss



FOCUS 460 PG 4
Lack,
Weiß Ultra-Hochglanz

FOCUS 460 PG 4
Lacquer,
white ultra high gloss



FOCUS 462 PG 4
Lack, Magnolia
Ultra-Hochglanz

FOCUS 462 PG 4
Lacquer,
ivory ultra high gloss



FOCUS 467 PG 4
Lack,
Sand Ultra-Hochglanz

FOCUS 467 PG 4
Lacquer,
sand ultra high gloss



INLINE 551 PG 5
Lack,
Alpinweiß matt

INLINE 551 PG 5
Lacquer,
honed alpine white

Technische Daten Technical data



GENT 741 PG 5
Lacklaminat, Steingrau

GENT 741 PG 5
Lacquered laminate, stone grey



CREDO 764 PG 6
Lacklaminat, Alpinweiß

CREDO 764 PG 6
Lacquered laminate, alpine white



CREDO 765 PG 6
Lacklaminat, Schiefergrau

CREDO 765 PG 6
Lacquered laminate, slate grey



KANSAS 597 PG 7
Eiche Sierra Nachbildung

KANSAS 597 PG 7
Sierra oak reproduction



CASCADA 774 PG 7
Lacklaminat, Weiß

CASCADA 774 PG 7
Lacquered laminate, white



CASCADA 772 PG 7
Lacklaminat, Steingrau

CASCADA 772 PG 7
Lacquered laminate, stone grey



CASCADA 776 PG 7
Lacklaminat, Schilf

CASCADA 776 PG 7
Lacquered laminate, reed green



SYLT 847 PG 7
Lack, Alpinweiß matt

SYLT 847 PG 7
Lacquer, honed alpine white



SYLT 849 PG 7
Lack, Magnolia matt

SYLT 849 PG 7
Lacquer, honed ivory



SYLT 851 PG 7
Lack, Schwarz matt

SYLT 851 PG 7
Lacquer, honed black



CASTELLO 390 PG 8
Magnolia gewischt

CASTELLO 390 PG 8
Washed ivory



CEMENTO 803 PG 8
Lack, Zementgrau

CEMENTO 803 PG 8
Lacquer, cement grey



LUX 817 PG 9
Lack, Alpinweiß Hochglanz

LUX 817 PG 9
Lacquer, alpine white high gloss



LUX 814 PG 9
Lack, Weiß Hochglanz

LUX 814 PG 9
Lacquer, white high gloss



LUX 816 PG 9
Lack, Magnolia Hochglanz

LUX 816 PG 9
Lacquer, ivory high gloss



LUX 819 PG 9
Lack, Seidengrau Hochglanz

LUX 819 PG 9
Lacquer, satin grey high gloss



LUX 823 PG 9
Lack, Schiefergrau Hochglanz

LUX 823 PG 9
Lacquer, slate grey high gloss

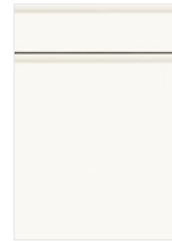

PURA 834 PG 9
Lack, Weiß Hochglanz

PURA 834 PG 9
Lacquer, white high gloss



CHALET 885 PG 9
Lack, Weiß matt

CHALET 885 PG 9
Lacquer, honed white



CHALET 883 PG 9
Lack, Magnolia matt

CHALET 883 PG 9
Lacquer, honed ivory



CHALET 881 PG 9
Lack, Sand matt

CHALET 881 PG 9
Lacquer, honed sand



YORK 905 PG 9
Echtholz, Magnolia lackiert

YORK 905 PG 9
Genuine wood, lacquered ivory



YORK 901 PG 9
Echtholz, Seidengrau lackiert

YORK 901 PG 9
Genuine wood, lacquered satin grey

BENKEPLATER WORKTOPS

70-71



066 Schiefer Nachbildung
066 Slate décor reproduction



070* Seidengrau
070* Satin grey



078 Eiche San Remo Nachbildung
078 Sanremo oak reproduction



089* Steingrau
089* Stone grey



097 Eiche Havanna Nachbildung
097 Havana oak reproduction



117 Copper Vintage Nachbildung
117 Vintage Copper décor



123 Eiche Virginia Nachbildung
123 Virginia oak reproduction



186 Schwarz
186 Black



192 Eiche Provence Nachbildung
192 Oak Provence reproduction



193* Alpinweiß
193* Alpine white



194* Schiefergrau
194* Slate grey



196 Eiche Ontario Nachbildung
196 Ontario oak reproduction



198 Eiche Sierra Nachbildung
198 Sierra oak reproduction



204 Ponderosa Pine Nachbildung
204 Ponderosa pine reproduction



215 Stromboli hell Nachbildung
215 Strombolian light reproduction



220 Arizona Pine Nachbildung
220 Arizona pine reproduction



225 Stammeiche Nachbildung
225 Stem oak reproduction



226 Dekor Metal Art Nachbildung
226 Metal art décor



265 Rusty Plates Nachbildung
265 Rusty plates reproduction



266 Caledonia
266 Caledonia



272 Balkeneiche Nachbildung
272 Timber oak reproduction



273 Carrara Nachbildung
273 Carrara marble reproduction



274 Marmor Teramo Nachbildung
274 Teramo marble reproduction



316 Maracaibo hell Nachbildung
316 Maracaibo light décor



319 Dekor Oxid
319 Oxid décor



330* Beton grau Nachbildung
330* Concrete grey reproduction



344* Granit schwarz geflammt Nachbildung
344* Black granite décor



345 Eiche Yukon Nachbildung
345 Yukon oak reproduction



347 Taxus Nachbildung
347 Taxus reproduction



352 Eiche Halifax Nachbildung
352 Sherwood oak reproduction



353* Weißbeton Nachbildung
353* White Concrete reproduction



354* Beton schiefergrau Nachbildung
354* Concrete Slate Grey reproduction



355* Ferro Bronze Nachbildung
355* Ferro bronze décor



356 Endgrain Oak Nachbildung
356 Endgrain oak reproduction



376* Limestone Nachbildung
376* Limestone reproduction



377 Eiche geölt Nachbildung
377 Oiled oak reproduction



378 Schwarzbeton Nachbildung
378 Black Concrete reproduction



379 Eiche Somerset Nachbildung
379 Somerset oak reproduction



393 Vintage Oak Nachbildung
393 Vintage oak reproduction



394 Travertin sandbeige Nachbildung
394 Champagne travertine reproduction



395 Verso Nachbildung
395 Verso reproduction



396 Terrazzo grau Nachbildung
396 Grey terrazzo reproduction



Arbeitsplatte APN mit N-Kante
Worktop APN with N edge



Arbeitsplatte APD mit Dekorkante
Worktop APD with décor edge

XTRA



367* Eiche Artisan Nachbildung
367* Artisan oak reproduction



368 Mixwood Nachbildung
368 Mixedwood reproduction



369* Schiefer steingrau Nachbildung
369* Stone grey slate reproduction















373* Grauschiefer Nachbildung
373* Grey slate reproduction

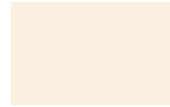
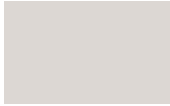

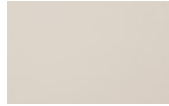









Eine Ansicht der kompletten Dekorlänge finden Sie auf www.nobilia.de
A view of the entire length of the décor can be found at www.nobilia.de

* tilgjengelig også i 16mm tykk, Slim-line benkeplater
* Also available as Slim Line worktop, 16 mm thick.

SKROGFARGE CARCASE DÉCORS

					
193 Alpinweiß 193 Alpine white	060 Alpinweiß Glanz 060 Alpine white gloss	106 Weiß 106 White	022 Weiß Glanz 022 White gloss	120 Magnolia matt 120 Ivory matt	116 Magnolia Glanz 116 Ivory gloss
					
070 Seidengrau 070 Satin grey	089 Steingrau 089 Stone grey	122 Sand 122 Sand	194 Schiefergrau 194 Slate grey	123 Eiche Virginia Nachbildung 123 Virginia oak reproduction	078 Eiche San Remo Nachbildung 078 Sanremo oak reproduction
					
198 Eiche Sierra Nachbildung 198 Sierra oak reproduction	097 Eiche Havanna Nachbildung 097 Havana oak reproduction				

COLOR CONCEPT COLOR CONCEPT

					
241 Sonnengelb 241 Maize Yellow	248 Farn 248 Fern	254 Aqua 254 Aqua	257 Salbei 257 Sage	265 Rusty Plates Nachbildung 265 Rusty plates reproduction	266 Caledonia 266 Caledonia
					
272 Balkeneiche Nachbildung 272 Timber oak reproduction	273 Carrara Nachbildung 273 Carrara marble reproduction	274 Marmor Teramo Nachbildung 274 Teramo marble reproduction	355 Ferro Bronze Nachbildung 355 Ferro bronze décor		

Håndtak i rustfritt stål Handles in stainless steel finish

**013* Metallgriff**
Edelstahlfarbig013* Metal handle
Stainless steel finish**019* Metallgriff**
Edelstahlfarbig019* Metal handle
Stainless steel finish**042 Metallgriff**
Edelstahlfarbig042 Metal handle
Stainless steel finish**062 Metallgriff**
Edelstahlfarbig062 Metal handle
Stainless steel finish**067 Metallgriff**
Edelstahlfarbig067 Metal handle
Stainless steel finish**069 Metallgriff**
Edelstahlfarbig069 Metal handle
Stainless steel finish**077 Metallgriff**
Edelstahlfarbig077 Metal handle
Stainless steel finish**098 Metallgriff**
Nickel matt098 Metal handle
Matt nickel**183 Metallgriff**
Edelstahlfarbig183 Metal handle
Stainless steel finish**186 Metallgriff**
Edelstahlfarbig186 Metal handle
Stainless steel finish**218 Metallgriff**
Edelstahlfarbig/
Chrom Glanz218 Metal handle
Stainless steel finish/
Brilliant chrome**221 Metallgriff**
Edelstahlfarbig221 Metal handle
Stainless steel finish**237 Metallgriff**
Edelstahlfarbig237 Metal handle
Stainless steel finish**263 Metallgriff**
Edelstahlfarbig263 Metal handle
Stainless steel finish**279 Metallgriff**
Edelstahlfarbig279 Metal handle
Stainless steel finish**331 Metallgriff**
Edelstahlfarbig331 Metal handle
Stainless steel finish**508 Metallgriff**
Edelstahlfarbig508 Metal handle
Stainless steel finish**544 Metallgriff**
Edelstahlfarbig544 Metal handle
Stainless steel finish**549 Metallgriff**
Edelstahlfarbig549 Metal handle
Stainless steel finish**552 Metallgriff**
Edelstahlfarbig552 Metal handle
Stainless steel finish**602 Metallgriff**
Edelstahlfarbig602 Metal handle
Stainless steel finish**608 Metallgriff**
Edelstahlfarbig608 Metal handle
Stainless steel finish**708 Metallgriff**
Edelstahlfarbig708 Metal handle
Stainless steel finish**801 Metallgriff**
Edelstahlfarbig801 Metal handle
Stainless steel finish

Håndtak antrasitt/ Sort Handles in Anthracite/Black

**563 Metallgriff**
Schwarz/Edelstahl-
farbig563 Metal handle
Black/Stainless steel
finish**570 Metallgriff**
Schwarz570 Metal handle
Black**595 Metallgriff**
Schwarz/Edelstahl-
farbig595 Metal handle
Black/Stainless steel
finish**616 Gusseisengriff**
Schwarz616 Cast iron handle
Black**707 Metallgriff**
Anthrazit gebürstet707 Metal handle
Brushed anthracite

Knotter Knobs

**610 Gusseisenknopf**
Schwarz610 Cast iron knob
Black**677 Metallknopf**
Edelstahlfarbig677 Metal knob
Stainless steel finish**678 Metallknopf**
Edelstahlfarbig678 Metal knob
Stainless steel finish**679 Metallknopf**
Schwarz679 Metal knob
Black

* Se salgshåndbok for vårt omfattende utvalg av interiørbeslag og tilbehør.

*Please refer to our sales manual for our complete range of handles.

* Disse håndtakene har er pris tillegg.

*This handle requires a surcharge.

Håndtak med krom behandling Handles with effect finishing



056 Metallgriff
Used look

056 Metal handle
Used look



088 Metallgriff
Anthrazit gebürstet

088 Metal handle
Brushed anthracite



099 Metallgriff
Industrial Style

099 Metal handle
Industrial Style



119 Metallgriff
Altsilberfarbig

119 Metal handle
Antique silver colour



190* Bügelgriff
Chrom Glanz

190* Bow handle
Brilliant chrome



192 Metallgriff
Chrom Glanz

192 Metal handle
Brilliant chrome



271 Metallgriff
Titanfarbig

271 Metal handle
Titanium-coloured



280 Metallgriff
Alteisenfarbig

280 Metal handle
Antique iron colour



284 Metallgriff
Altsilberfarbig

284 Metal handle
Antique silver colour



358 Metallgriff
Titanfarbig

358 Metal handle
Titanium-coloured



509 Metallgriff
Grau

509 Metal handle
grey



556 Metallgriff
Altsilberfarbig

556 Metal handle
Antique silver colour



733 Metallgriff
Schwarzchrom

733 Metal handle
Chromed black



737 Holz-Metallgriff
Eiche/Schwarz

737 Wood/Metal
handle Oak/Black



739* Metallgriff
Schwarz

739* Metal handle
black



799 Metallgriff
Schwarzchrom

799 Metal handle
Chromed black

Grepelist Bar handles



240* Griffleiste
Schwarz

240* Bar handle
Black



300* Bar handle
Stainless steel finish



350* Griffleiste
ilfarbig

350* Bar handle
Stainless steel finish



430* Griffleiste
Edelstahlfarbig

430* Bar handle
Stainless steel finish



550* Griffleiste
Edelstahlfarbig

550* Bar handle
Stainless steel finish



600* Griffleiste
Schwarz

600* Bar handle
Black



690* Griffleiste
Alpinweiß

690* Bar handle
alpine white



710* Griffleiste
Steingrau

710* Bar handle
stone grey



730* Griffleiste
Schiefergrau

730* Bar handle
slate grey



760* Griffleiste
Edelstahlfarbig

760* Bar handle
Stainless steel finish



870* Griffleiste
Schwarz

870* Bar handle
Black

Store håndtak Railing handles



370* Relingstange
Edelstahlfarbig

370* Railing handle
Stainless steel finish



620* Relingstange
Schwarz

620* Railing handle
Black



650* Relingstange
Edelstahlfarbig

650* Railing handle
Stainless steel finish

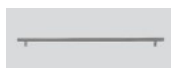

900* Relingstange
Edelstahlfarbig

900* Railing handle
Stainless steel finish



930* Relingstange
Edelstahlfarbig

930* Railing handle
Stainless steel finish

* Disse håndtakene har er pris tillegg.

*This handle requires a surcharge.

Alle rettigheter til tekniske endringer, leveringsmuligheter, feil og utskriftsrelaterte fareavvik er forbeholdt. Alle møbleringseksempler er uforpliktende.

All rights to technical alterations, delivery possibilities, errors and printing-related colour deviations are reserved. All furnishing examples are non-binding.



Kvalitet i fra Tyskland

Quality
made in Germany



Utvalgte materialer, utmerket utførelse, perfektjon helt til den minste detalj: badene våre er utviklet og produsert i henhold til det høyeste kvalitetskriterier. Våre produkter er utelukkende laget i Tyskland.

Før produktene våre går i produksjon, vil alle materialer som brukes blir utsatt for en omfattende testprosedyrer i laboratoriet for en minimums levetid på 15 å. de blir, inspisert og sertifisert av et uavhengig internasjonale institutt. Tross alt er våre kundes tilfredshet vårt mål.

Selected materials, excellent workmanship, perfection right down to the finest detail: our bathrooms are developed and manufactured according to the highest quality criteria. Our products are made exclusively in Germany.

Before our products go into production, all the materials used are subjected to extensive test procedures in the laboratory for a minimum service life of 15 years and inspected and certified by independent international institutes. After all, our customers' satisfaction is our benchmark.





Keo

www.keo.no | post@keo.no